

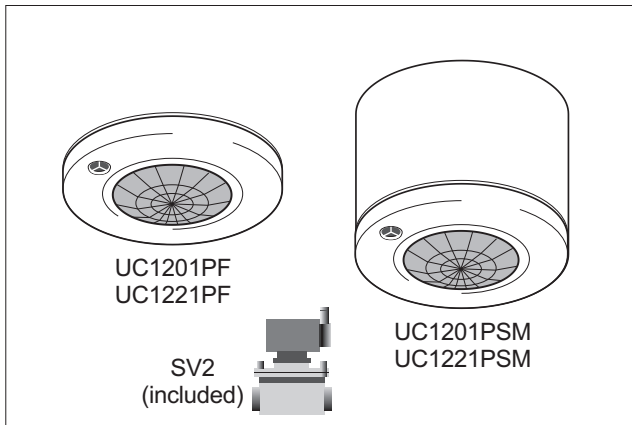

by Honeywell

LightSpot Washroom Series
UC1201PF / UC1201PSM
UC1221PF / UC1221PSM



Installation and Commissioning
Instructions

Note: Infrared Programmer required for commissioning

HP2000, HP10 or HP18 for UC1201PF/SM

HP2000 or HP10 for UC1221PF/SM

Please note that only the HP2000 offers the full range of programming options

User override available via HC5 or HC6 Hand-held Controllers

LightSpot presence-detecting washroom controls

Only suitably qualified personnel should install this equipment.

LightSpot washroom controls are high performance presence detectors with photocell. The photocell can operate in three modes: Passive, Active or Disabled. Further information can be found overleaf.

Fixing

UC1201PSM / UC1221PSM - The housing may be secured to a hard surface or a BESA box. The unit fits into the housing with a simple bayonet action.

UC1201PF / UC1221PF - Depth required behind ceiling: 62mm from front flange plus an allowance for the minimum bend radius of the cable. Sinking box fits into an 89mm diameter hole in ceiling tile or plasterboard ceiling. To avoid damage to ceiling tile, do not overtighten. No access above the ceiling is necessary.

Note: Do not mount within 25cm of a luminaire.

Solenoid Valve

The solenoid valve must be plumbed into the water feed to the urinal header tank and connected to the LooSpot detector using 230V cable. The required direction of water flow is shown on the valve. Avoid contamination by swarf, flux etc.

Connection Examples

Single UC1201PF or UC1201PSM

Controlling water

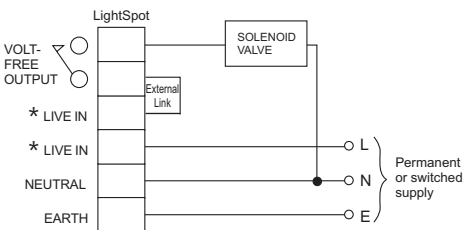

* The Live terminals are internally linked

Single UC1221PF or UC1221PSM

The UC1221 has two outputs, one influenced by the photocell (R1), the other not (R2). This is useful in applications where a fan or water is being controlled in addition to any lighting.

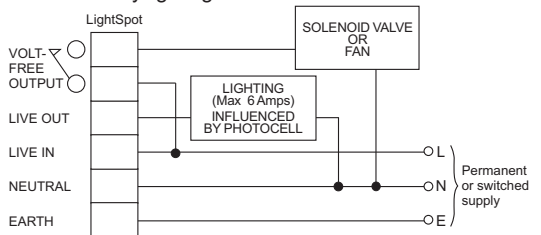

Multiple UC1201PF or UC1201PSM

Larger areas can be covered by connecting extra units in parallel. The total load current must not exceed 6 Amps in case only one unit is activated.

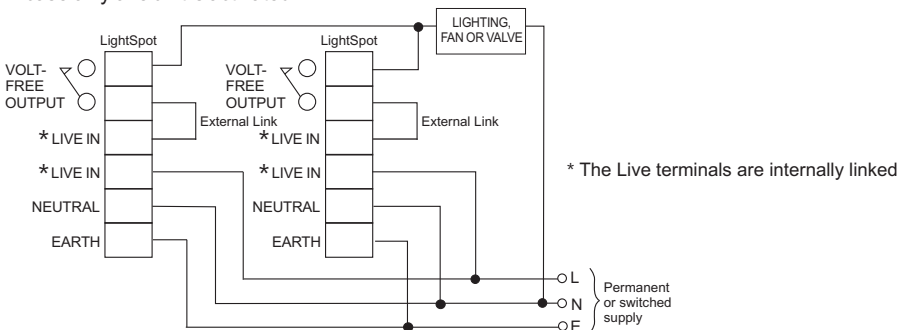

* The Live terminals are internally linked

Important Additional Notes

1. All terminals on this product are provided for final connections. It is not intended that the product be used as a junction box for looping cables.
2. A means for disconnection must be incorporated in the fixed wiring in accordance with the current wiring regulations.
3. This equipment switches lights no more frequently than would a responsible human occupant. However, manufacturers of some lighting types (e.g. '2D' luminaires) may specify a maximum number of switching cycles in order to achieve a predicted lamp life. Please check with the manufacturer of the luminaires to ensure that they are compatible with automatic controls in this respect.

HP10 Parameter Options for UC12x1P

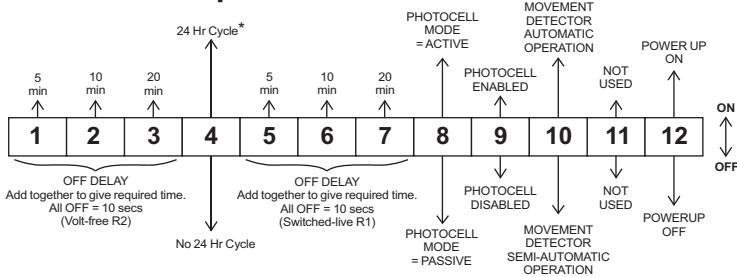

Please note that additional parameters are available via the HP2000 Programmer.

Off Delay

Independent Off Delays may be set for each output between 5 and 35 minutes. A 10-second Off Delay is available for walk-testing the product. In a typical office environment a 20-minute Off Delay is usually satisfactory

Movement Detector Operation (Automatic / Semi-Automatic)

Where absence detection is required (ie the user manually turns lights ON if required but lights still turn off automatically once an area is vacated), semi-automatic operation can be set via the programmer. It should be noted that this mode of operation affects only the switched-live output. Where semi-automatic operation is required on both outputs, please contact Ex-Or for assistance.

Power Up Setting (On/Off)

Set to ON the detector will automatically switch its outputs on when Mains is applied. If set to OFF, the detector will power up without turning its outputs on, wait for 15 seconds and THEN look for movement. Only if the area is occupied will the outputs switch on at this time. The detector must be set to Power Up ON when used in conjunction with semi-automatic operation.

Photocell Operation (Passive/Active/Disabled)

Both the single-output detector and the dual-output detector have an in-built photocell. On the dual-output detector the photocell does not affect the volt-free output - i.e. the volt-free output will turn ON regardless of natural light levels when occupancy is detected. The photocell has three modes of operation - Passive, Active and Disabled. Its operational behaviour is governed by the setting chosen and by the values stored in the Upper and Lower thresholds.

Passive - The photocell will inhibit turn-on of the controlled load if sufficient natural light is available. It will not turn the load off whilst an area is occupied

Active - The photocell will turn the controlled load on and off as required whilst natural light levels fluctuate during a period of occupancy. This mode of operation operates in conjunction with a passing cloud timer (PCT). The PCT is asymmetrical in operation - the load will be switched on immediately that the light level falls below the lower set point, however, the load switches off only if the light level exceeds the upper threshold *continuously* for a period equal to the Off Delay.

Disabled - The photocell has no effect.

24hr Cycle (Yes/No)

If the detector has seen no movement for 24 hours, the output (selectable on dual-output version, default = volt-free) will be switched ON for the duration of the time delay, if 24hr Cycle is set to ON. Used in conjunction with a suitable valve the need for separate urinal flush control is removed.

Commissioning

The units are supplied with factory default settings (power-up on, fully automatic operation, a 20 minute off delay, no 24hr cycle, photocell disabled). Programme using an infrared programming tool. Please note that the full range of parameters is accessible via the HP2000; the HP10 and HP18 offer different/limited programming options.

Walk-test Mode

Walk-test mode is used to check that the detector is operating as required. The short off-delay enables the installer to check that lights are switching on when movements are made at the edge of the detection zone. It is easier to carry out a walk-test when the photocell is not holding the lights off.

1. Change the Off Delay to 10 seconds using the HP10 or press 'TEST' (HP18) or 'Utilities/Walk Test/OK' (HP2000).
2. Move around the area that is being controlled, stopping for 10 seconds to allow the lights to switch off, before moving and triggering the lights back on. Re-programme the desired Off Delay once testing is complete. Note: If the HP2000 or HP18 was used to engage 'soft' walk test mode as described above, the programmed Off Delay will be automatically restored after 5 minutes.

Setting the Photocell (Photocell only affects the 'Live Out' output)

1. Wait until the time of day when the ambient light level is equal to the level at which you want the photocell to become active.
2. Using the HP2000, select 'Set Light Level' from the Utilities menu and press OK while pointing at the detector to store the current light level - the lights must be on prior to starting this process. The detector stores two values in Lower Threshold and Upper Threshold. This procedure can also be accomplished by using the HP10's 'Store' button or 'Set' on the HP18. (Editing of stored threshold values is not possible with HP10/HP18.)
3. If required, these values can be manually edited via the HP2000. Please note, these are not Lux levels but a representation of the light levels perceived by the detector at the time of the store command.

Note: If the photocell is set to Passive, only the value in the Lower Threshold is relevant.

If the photocell is set to Active, once the ambient light level drops below the Lower Threshold value, the lights will turn ON. If the ambient level exceeds the value of the Upper Threshold for the duration of the off-delay (Passing Cloud Timer) then the lights will turn ON. If the photocell is set to 'Disabled' when a Set Light Level operation is made, it will revert to operating in Passive mode.

Washroom Mode

Both the single-output and dual-output version of this product allow the control of water for washroom management applications (urinals). In order to maintain good standards of hygiene the products feature a washroom mode (24hr Cycle) that, if enabled, ensures that when urinals have not been used for 24 hours (i.e. the controlled area has been unoccupied), a hygiene flush occurs. Please note that when used on the single-output unit (controlling lighting *and* urinals), it is not possible to have the photocell influence the output status as this could prevent flushing of the urinals. On the dual-output unit the 'flush' will occur on the volt-free output although this can be changed via the HP2000 Programmer.

Technical Data

OPERATING VOLTAGE: 230V 50Hz (UK & Europe)

RECOMMENDED CIRCUIT PROTECTION: 10 Amps

TERMINAL CAPACITY: 2 x 2.5mm²

MAXIMUM LOAD: 6 Amps per output [not exceeding 10A in total on UC1221P]

MAXIMUM RECOMMENDED MOUNTING HEIGHT: 3 metres

RANGE: Cone-shaped detection pattern, diameter (at floor level) = 2.4 x mounting height

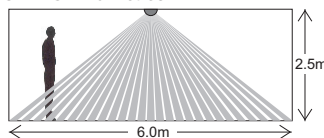

Dimensions

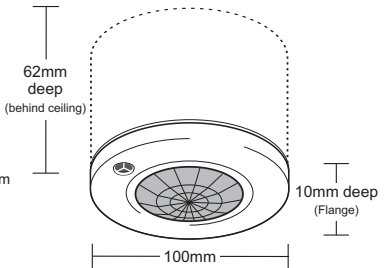

PHOTOCELL: Adjustable 50-5000 lux via Programmer

OFF DELAY 1 & 2: Adjustable via Programmer - factory pre-set to 20 mins

Programmer options: 1 minute - 96 hours / Disabled (via HP2000); 5 - 35 minutes (via HP10) (also 5, 10 or 20 minutes via HP18 - UC1201PF/SM only) - plus 10-second Walk-test Mode On UC1221PF/SM each output is independently adjustable via HP2000 or HP10

COLOUR: White

MATERIAL: Flame retardant PC/ABS

WEIGHT: 200g approx

IP RATING: 3X

Ex-Or

Novar ED&S Limited
Haydock Lane, Haydock, Merseyside WA11 9UJ

Tel: + 44 (0)1942 719229

Fax: +44 (0)1942 508753

Email: technicalsales.ex-or@honeywell.com

www.ex-or.com

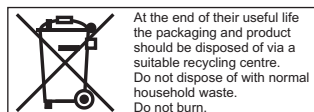

At the end of their useful life the packaging and product should be disposed of via a suitable recycling centre. Do not dispose of with normal household waste. Do not burn.



W4250F