

INTERRUTTORE ORARIO DIGITALE

Manuale d'Uso

memo NFC

Digital time switch: User Manual



CE

Vemer
SPA

Index

■ Technical features	page	3		
■ Safety warnings	page	4		
■ Dimensions	page	4		
■ Wiring diagrams	page	5		
■ Display and keyboard description	page	6		
■ Initial operation	page	7		
■ Start page (or main)	page	8		
■ Menu description	page	11		
■ Settings menu	page	12		
Language setting menu	page	13		
Date setting menu	page	14		
Time setting menu	page	15		
Daylight saving time (DST)/winter time (CET) change setting menu	page	16		
Random switchings setting menu	page	18		
Protection PIN setting menu	page	19		
■ Program menu	page	20		
Program menu: new	page	25		
Program menu: new daily timed	page	26		
Program menu: new weekly timed	page	27		
Program menu: new yearly timed	page	28		
Program menu: new holiday timed	page	30		
Program menu: check	page	32		
Program menu: modify	page	34		
Program menu: copy	page	36		
Program menu: delete	page	37		
			■ NFC menu	page 38
			■ Hour counter menu	page 40
			■ Reset menu	page 42
			■ Firmware menu	page 44
			■ Error signals	page 45
			■ Battery management	page 46
			■ Reference standards	page 46

USER MANUAL

The digital time switches of memo series are electronic devices for the management of the electrical utilities over time. They allow the time programming (periodicity: daily, weekly or yearly) and have a NFC interface that allows it to be coupled with mobile devices (smartphone or tablet).

Thanks to the free app that can be downloaded from Google Play store, it is possible to program and make settings directly on your smartphone and then transfer all the data to the time switch.

The reverse procedure is also possible, i.e. to copy the programming of a time switch on your mobile device.

The backup battery allows you to keep the settings even in case of black-out and can be replaced through the cover on the back of the time switch.

The time switches of Memo series are devices that perform actions of 1B type , intended to operate in environments with III overvoltage category and pollution degree 2 in accordance with EN 60730-1 standard.

Code	Model	Description
VE339800	memo DW	Daily/weekly time switch 1 channel with NFC interface
VE341400	memo DW2	Daily/weekly time switch 2 channels with NFC interface
VE340600	memo Y	Daily/weekly or yearly time switch 1 channel with NFC interface
VE342200	memo Y2	Daily/weekly or yearly time switch 2 channels with NFC interface

TECHNICAL FEATURES

- Power supply: 230 Vac (-15% ÷ +10%) 50/60 Hz
- Power consumption:
 - memo DW, memo Y: 1W (3.5 VA)
 - memo DW2, memo Y2: 1.5W (5.5 VA)
- Lithium backup battery: 3V, CR2032 type (replaceable)
- Output:
 - memo DW, memo Y: 1 monostable change-over relay with maximum switchable load of 16(10)A / 250V
 - memo DW2, memo Y2: 2 monostable change-over relays with maximum switchable load of 16(10)A / 250V
- Display LCD with backlighting (active with AC power supply)
- NFC communication interface
- Storable programs:
 - memo DW, memo Y: 120 events
 - memo DW2, memo Y2: 120 events (divisible on 2 channels)
- Actions type: 1B
- Operating temperature: -20 ÷ +50°C
- Operating humidity: 20 ÷ 90% non condensing
- Storage temperature: -10 ÷ + 70°
- Container: 2 DIN modules
- Protection degree: IP20
- Insulation: reinforced between accessible parts (front) and all the other terminals

SAFETY WARNINGS

■ **During product installation and operation it is necessary to observe the following instructions:**

- 1) The instrument must be installed by a qualified person, strictly in observance of the connection diagrams shown in this manual.**
- 2) After installation inaccessibility to the terminals without using dedicated tools must be guaranteed.**
- 3) Before accessing the connection terminals, make sure that the leads are not live.**
- 4) Do not connect or feed the instrument if any part of it is damaged.**
- 5) The product must be installed and activated in compliance with current electric systems standards.**
- 6) Do not use the product for anything other than the indicated purpose.**
- 7) In the electrical system upstream of the device must be installed a protection device against the overcurrents**
- 8) The product can be used in environments with Measurement Category III and Pollution degree 2, according to the Standard EN 60730-1.**

DIMENSIONS

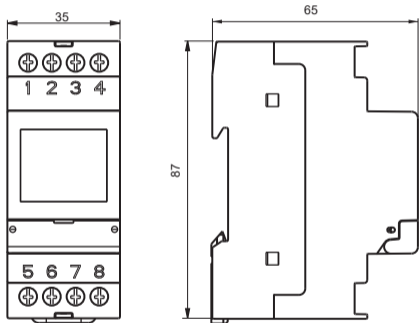

WIRING DIAGRAMS

Memo DW, Memo Y

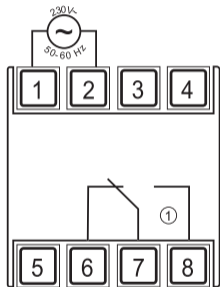

Memo DW2, Memo Y2

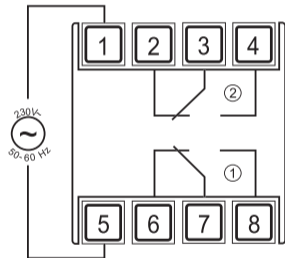

DISPLAY AND KEYBOARD DESCRIPTION

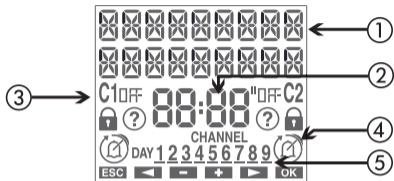

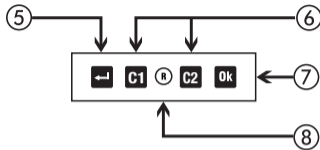

- ① General indications
- ② Time indication
- ③ Channel 1/channel 2 status indication
 - _n / OFF channel status
 - 🔒 blocked switchings
 - ❓ active random switchings
 - active holiday program
 - 🔔 active pulse program
 - 🕒 active manual program
- ④ Day of the week (DAY) indication



- ⑤ Turn on the display
Access the menu
ESC (one level back)
- ⑥ Key "C1": decrease datum/previous menu/ switching channel 1/
lock channel 1
Key "C2": increase datum/next menu/ switching channel 2 /
lock channel 2
- ⑦ Confirm selection
- ⑧ Hardware reset

Key "OK" + "C1" (3 sec): random switching channel 1
Key "OK" + "C2" (3 sec): random switching channel 2

INITIAL OPERATION

- Once out of the package, memo is off: press the key  and wait a moment before activating the display
- The set language is Italian. To change it, press the key  for at least 3 seconds. Choose among: Italian, English, Spanish, French or German and confirm with 
- Make connections following the diagrams on page 5 of this manual
- Power memo: the backlighting turns on permanently
- The presence of the backup battery allows the memo to have updated date and time.
To make the other settings follow the following steps:

Date	- format: DD/MM/YY - 1 st day of the week: Monday
Daylight Saving time (DST) change: active	- start of daylight saving time (DST): last Sunday of March at 02:00 o'clock - end of daylight saving time (DST): last Sunday of October at 03:00 o'clock
Random switchings:	- minimum: 1 minute - maximum: 5 minutes
Keyboard lock with PIN:	disabled (---)
NFC interface	active

START PAGE (or main)

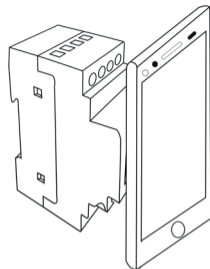
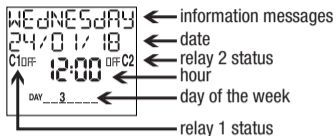

NOTE: the NFC interface is active only when the memo displays the initial (main) page. The action range of the NFC interface is deliberately limited: in order for the memo and the smartphone to communicate, it is necessary to place the latter on the memo display.

Information messages

- day of the week
- product identification code and serial number
- battery status (only if discharged)
- NO SUPPLY*

- Press the key

← to access the menu of memo

C1 and C2 to change channel 1 and channel 2 status (only for memo DW2, memo Y2)

- * Only if memo is not powered by mains.

In this condition the backlighting is not active and the relay is in off status.

Access the store of your device, install and start the free app Memo – Vemer.

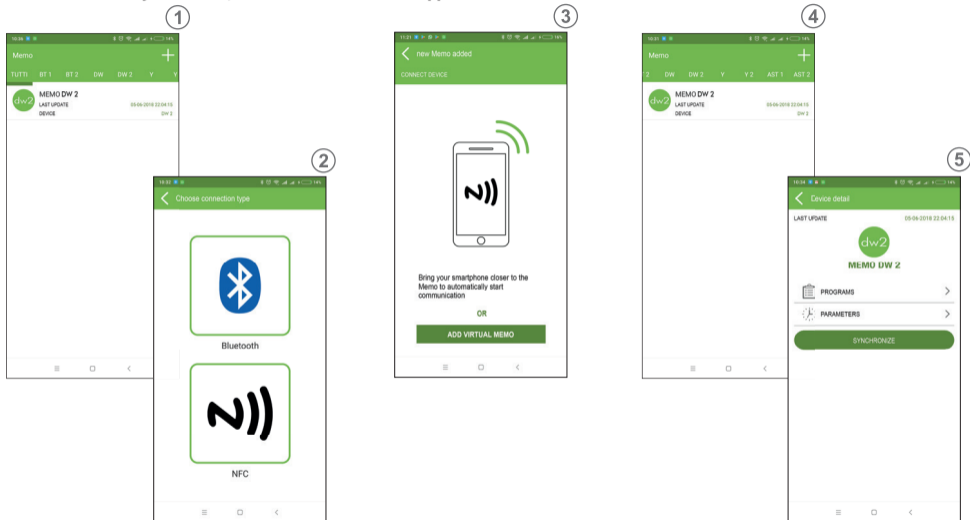

- ① At the start the app displays the list of the associated memo devices (both Bluetooth and NFC).
To associate a new memo NFC, press the symbol “+” in the upper right corner.
- ② In the “Choose connection type” screen, select NFC.
- ③ Place the smartphone on the display of the memo to be associated.

Note: each device is identified by the product code (for example VE339800) and by the serial number (for example 00000020). These informations can be viewed from the main page of the memo.

Warning: make sure visible that the display shows the main page (initial). Otherwise the NFC interface is not active and the device is not visible.

Note: from this screen you can create a virtual memo. With a virtual memo you can create programs even if you do not have a memo available. The programming and settings of the virtual memo can be saved in the app and then transferred to the memo.

- ④ The app shows the detected memo: do a tap on the memo to complete the association. Once the procedure is complete, the memo is added to the list of associated devices.
Select the memo on which to act from the list of associated devices.
- ⑤ The app displays the initial page of the selected memo. From this page you can:
 - a. Create new programs that will then be copied to the memo
 - b. View the parameters and associate an alias (name that identifies the time switch, such as “memo DW Belluno”) to the memo

MENU DESCRIPTION

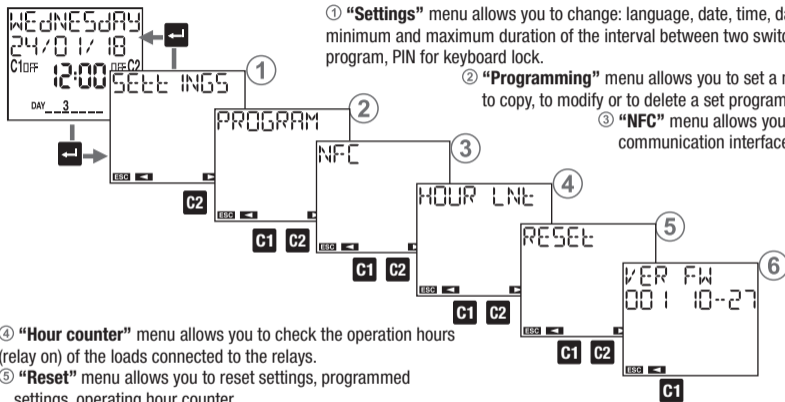

SETTINGS MENU

“Settings” menu allows you to view and eventually to modify the general operation settings of memo, such as:

- ① language
- ② date
- ③ time
- ④ automatic daylight saving time (DST) change
- ⑤ position (astronomical coordinates)
- ⑥ interval duration between two random switchings
- ⑦ keys protection by PIN

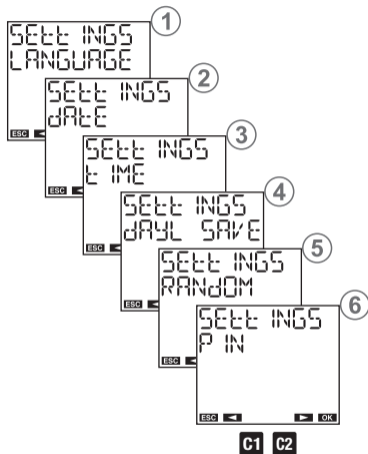

Language setting menu

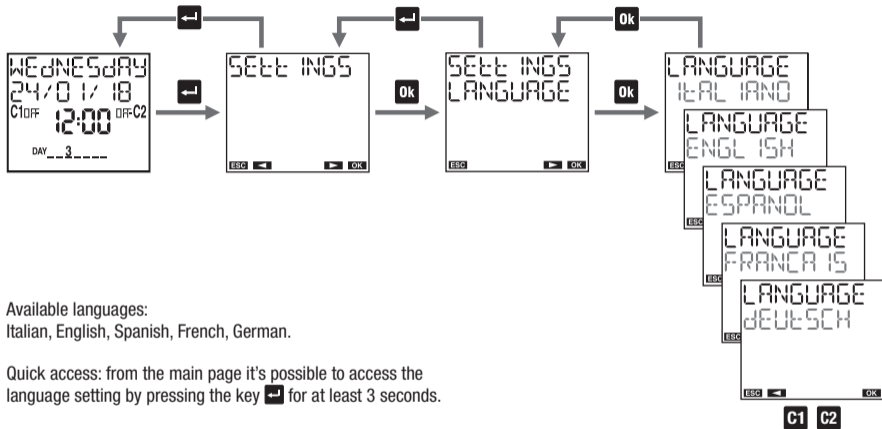

Date setting menu

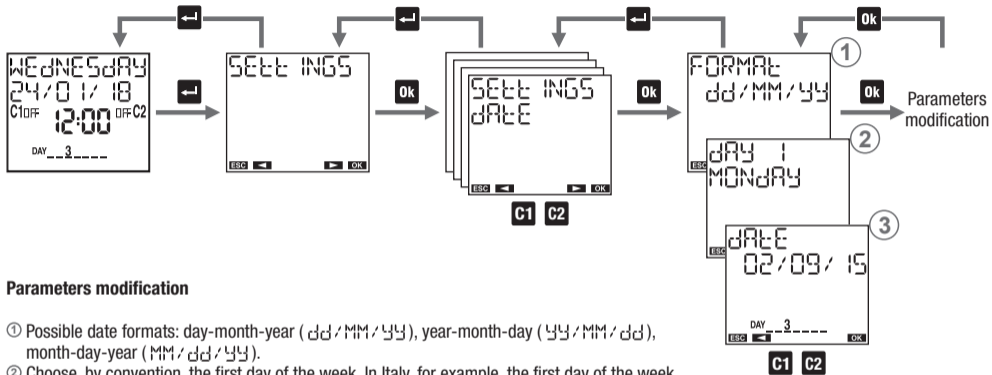

Parameters modification

- ① Possible date formats: day-month-year (**dd/MM/yy**), year-month-day (**yy/MM/dd**), month-day-year (**MM/dd/yy**).
- ② Choose, by convention, the first day of the week. In Italy, for example, the first day of the week is Monday, in the UK it's Sunday.
- ③ Enter the date: day, month, year.

Time setting menu

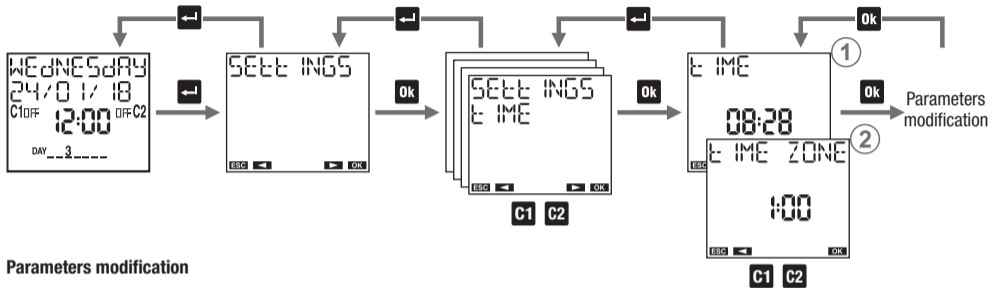

Parameters modification

Set the time: hours, minutes.

Daylight saving time (DST)/winter time (CET) change setting menu

Daylight saving time (DST)/winter time(CET) change and vice versa can occur in an automatic way. In this case, memo:

- increases by an hour in the passage from winter time (CET) to daylight saving time (DST)
- decreases by an hour in the passage from daylight saving time (DST) to winter time (CET)

For every change it's necessary to specify:



the week of the month during which the time change occurs (first, second, third, fourth, last)



the day of the week (Monday: 1, Tuesday: 2, ...)



the month



the hour and the minutes

In Italy, for example, daylight saving time (DST) begins occurs the last (LAST) Sunday (7) of March (03) at 02:00 o'clock, and ends the last (LAST) Sunday (7) of October (10) at 03:00 o'clock.

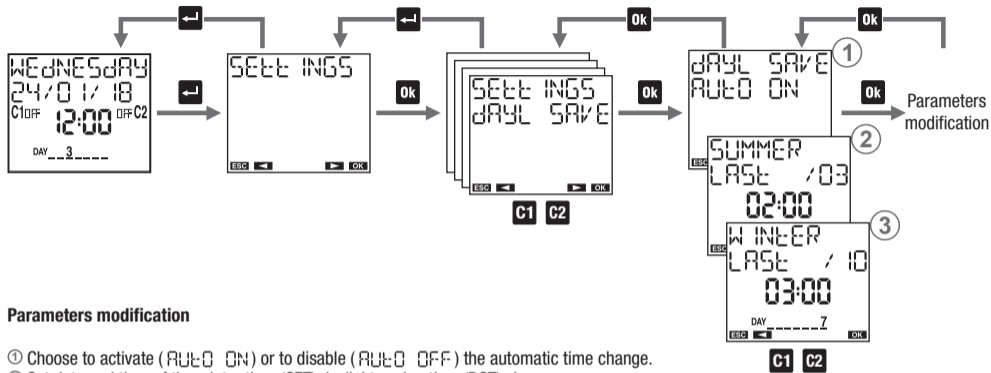

Parameters modification

- ① Choose to activate (AUTO ON) or to disable (AUTO OFF) the automatic time change.
- ② Set date and time of the winter time (CET) daylight saving time (DST) change.
- ③ Set date and time of the daylight saving time (DST) winter time (CET) change.

Random switchings setting menu

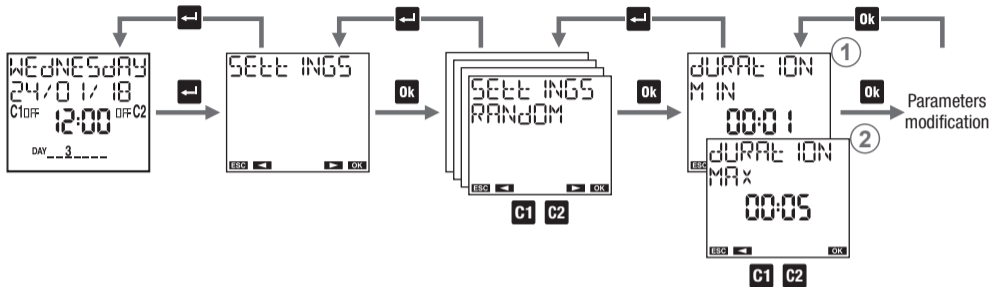

The “random switching ②” function (activated with the combination described on page 6) allows the channel on which it’s active to automatically switch and at random time intervals.

In this menu it’s possible to define the minimum and maximum duration of the time interval between two random switchings. Default minimum duration is 1 minute, maximum duration is 5 minutes.

Parameters modification

- ① Set the minimum duration. It’s possible to set values between 1 minute and the *maximum duration*.
 - ② Set the maximum duration. It’s possible to set values between the *minimum duration* and 23:59 hours.
- Note: setting the minimum duration equal to the maximum, the switchings will occur at fixed time intervals.

Protection PIN setting menu

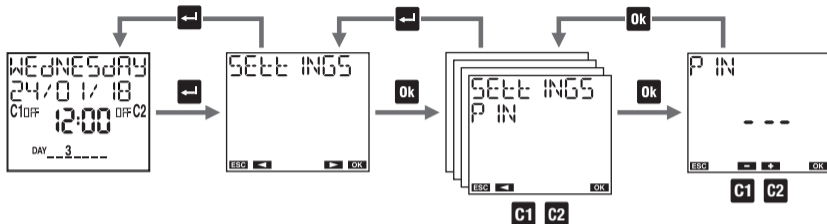

The protection code (PIN) is used to lock the keyboard and prevent changes by unauthorized persons. With active PIN protection, pressing any key, it's necessary to enter the PIN: if PIN is correct the keyboard unlocks; after 3 minutes without pressing a key, the keyboard will lock automatically.

To activate PIN protection:

- set a value between 000 and 999

To disable PIN protection:

- set "---" (located before 000 or after 999)

Note: If you have forgotten your PIN code to unlock memo it's necessary to carry out a hardware reset (see page 42).

PROGRAM MENU

The menu “program” allows you to:

- ① create a new program
- ② check created programs
- ③ change or delete a created program
- ④ copy all created programs of channel 1 on channel 2 and vice versa (only for memo DW2, memo Y2)
- ⑤ delete all programs of a channel

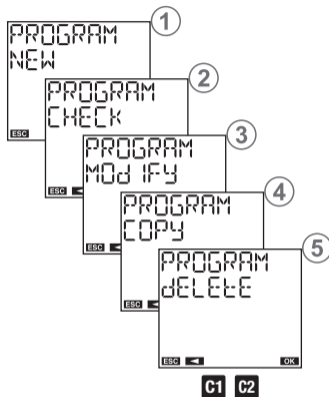

Select days

scroll through the days of the week from 1 to 7:

- by pressing the key **C2** to move to the next day without selecting the current day
- by pressing the key **Ok** to select/deselect the current day and move to the next

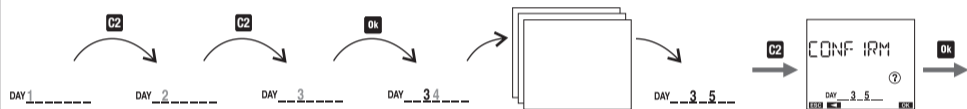

Programs types

- ON/OFF program: is composed of a switching of the ON relay and of a subsequent switching of the OFF relay. It can have a daily period (everyday with the same modes), weekly (every week with the same modes), yearly (all the years with the same modes. Available only on memo Y and memo Y2).
 - PULSE ON program: is an ON relay switching for a maximum duration of 59 seconds. It can have a daily period (everyday with the same modes), weekly (every week with the same modes), yearly (all the years with the same modes. Available only on memo Y and memo Y2).
 - PULSE OFF program: is a relay switching OFF for a maximum duration of 59 seconds. It can have daily period (everyday with the same modes), weekly (every week with the same modes), yearly (all the years with the same modes. Available only on memo Y and memo Y2).
 - HOLIDAY program: is a period of time defined by a start time and an end time within which all programmed switchings (of that channel) are disabled. The relay is in OFF position (OFF holiday) or in ON position (ON holiday).
- ⚠ **Important:** on the same channel can't coexist ON pulses and OFF pulses (if an ON pulse is already present, it's not possible to save a holiday OFF and vice versa).
- ⚠ **Important:** on the same channel can't coexist holiday ON programs and holiday OFF programs (if a holiday ON program is already present, it's not possible to save a holiday OFF program and vice versa).

Programs priority

The priority programs defines how memo manages the case in which programs with different period are running at the same time (1 indicates higher priority).

Program	Date* (specific year)	Yearly (specific month, every year)	Monthly (every month, every year)	Weekly	Daily
Holiday	1				
Pulse	2	3	4	5	6
On/Off	7	8	9	10	11

* Date: select day, month, year (program carried “only once in the life of the product”). If the month is not specified, the program is carried out all days xx of all months of the specified year.

Priority list on/off

In case in which, on the same channel, on/off programs are provided with different period (daily, weekly or yearly) to carry out in the same day, only the program with the highest priority is executed.

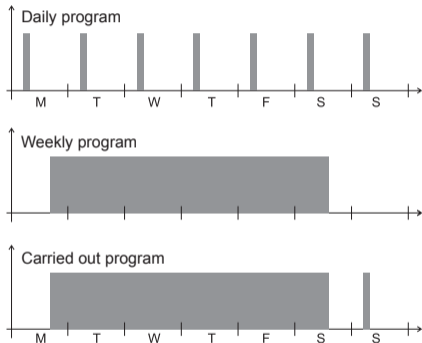

From this example it's possible to see that the daily event on Monday is not carried out because in the same day it is provided the beginning of the week program (even if the daily program

of Monday begins and ends before the beginning of the weekly program). Instead, the daily program of Sunday is carried out because it's the only one running for that day.

Holiday program

The holiday program just begins and ends exactly at the specified times.

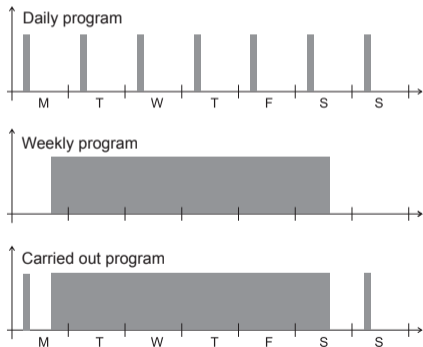

Program menu: new

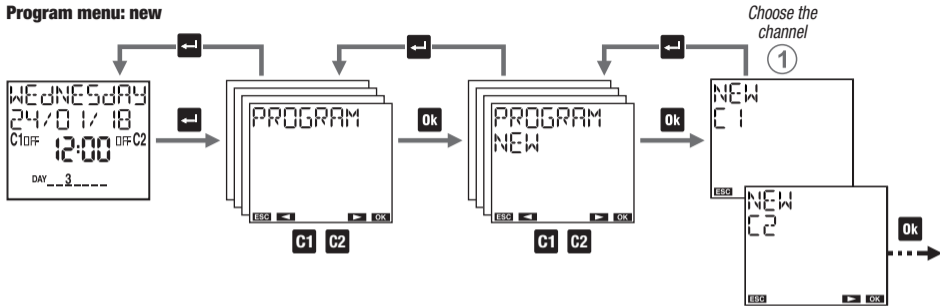

① Choose the channel to program (only for memo DW2 and memo Y2)

Program menu: new daily timed

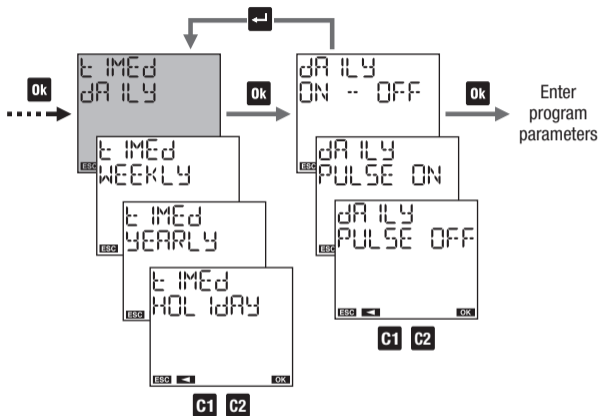

Program parameters

- on/off: on time and off time
- on pulse: time and pulse duration (max 59 seconds)
- off pulse: time and pulse duration (max 59 seconds)

Program menu: new weekly timed

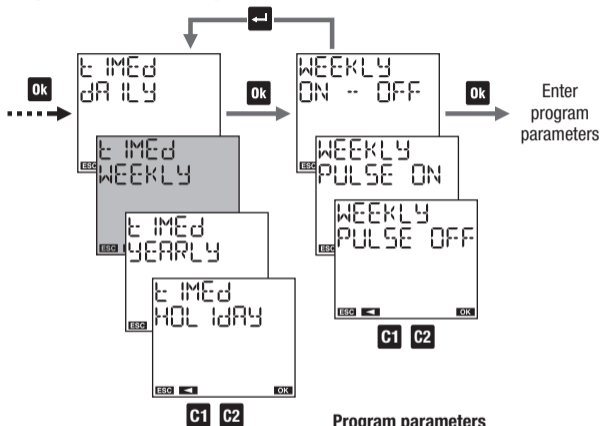

Program parameters

- on/off: day (or days)* and on time, day (or days) and off time
- on pulse: day (or days)* and pulse time, pulse duration (max 59 seconds)
- off pulse: day (or days)* and pulse time, pulse duration (max 59 seconds)

* See "Days selection" on page 21

Program menu: new yearly timed

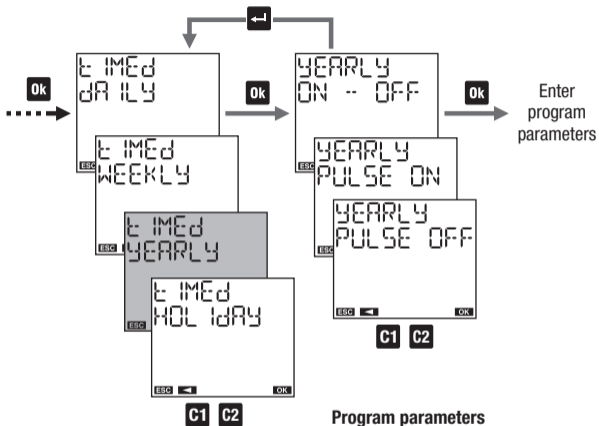

Program parameters

- on / off: day (or days) * and on time, day (or days) and off time
- on pulse: day (or days) * and pulse time, pulse duration (max 59 seconds)
- off pulse: day (or days) * and pulse time, pulse duration (max 59 seconds)

* see "How to choose the day (or days) in a yearly program" on p. 29

How to choose the day (or days) in a holiday program



① to set the program:

in the first, second, third, fourth or last week of the month
in / the day/s (Monday, ...) of the week just specified
the specified month (MM for all months)
the given year (YY for all years)

Nota: in this case, the yearly program must begin and end
in the same day. Otherwise ERROR 0 0 is signaled.

② to set the program on the last day:

-- /MM/YY of all months of all years
-- /VV/YY of the specified VV month of all years
-- /MM/ZZ of all months of the specified ZZ year
-- /VV/ZZ of the specified VV month of the specified ZZ year

③ to set the program on the day XX (1,2,3...):

xx /MM/YY of all months of all years
xx /VV/YY of the specified VV month of all years
xx /MM/ZZ of all months of the specified ZZ year
xx /VV/ZZ of the specified VV month of the specified ZZ year

Program menu: new holiday time

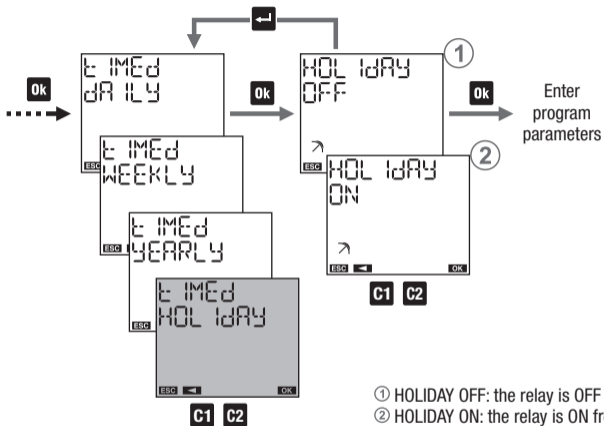

- ① HOLIDAY OFF: the relay is OFF from the beginning to the end of holiday program.
- ② HOLIDAY ON: the relay is ON from the beginning to the end of holiday program.

Program parameters

- beginning of the program
- end of the program

How to choose the day (or days) in a holiday astro program



① to set the program:

in the first, second, third, fourth or last week of the month
 in / the day/s (Monday, ...) of the week just specified
 the specified month (MM for all months)
 the given year (YY for all years)

Note: in this case, the holiday program must begin and end in the same day. Otherwise ERROR □ □ is signaled.

② to set the program on the last day:

--- /MM /YY of all months of all years
 --- /VV /YY of the specified VV month of all years
 --- /MM /ZZ of all months of the specified ZZ year
 --- /VV /ZZ of the specified VV month of the specified ZZ year

③ to set the program on the day XX (1,2,3...):

xx /MM /YY of all months of all years
 xx /VV /YY of the specified VV month of all years
 xx /MM /ZZ of all months of the specified ZZ year
 xx /VV /ZZ of the specified VV month of the specified ZZ year

Program menu: check

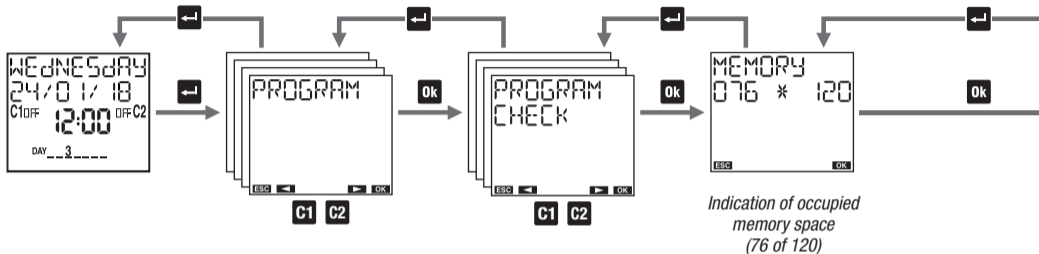

How to check a program

- ① choose the channel (only for memo DW2, memo Y2)
- ② choose the period: daily, weekly, yearly, holiday
- ③ choose the type: on/off, on pulse, off pulse

Note: a program requires more screens to be displayed:

- press the key **Ok** to move from the first to the second part of the same program
- press the keys **C1** and **C2** to switch from one program to another

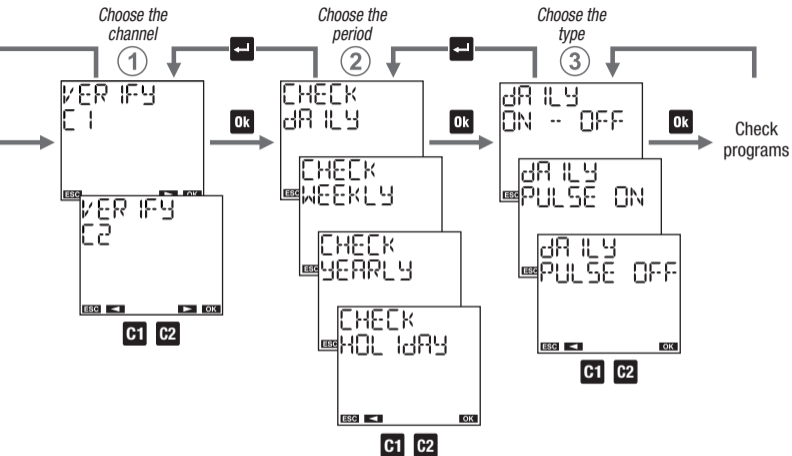

Program menu: modify

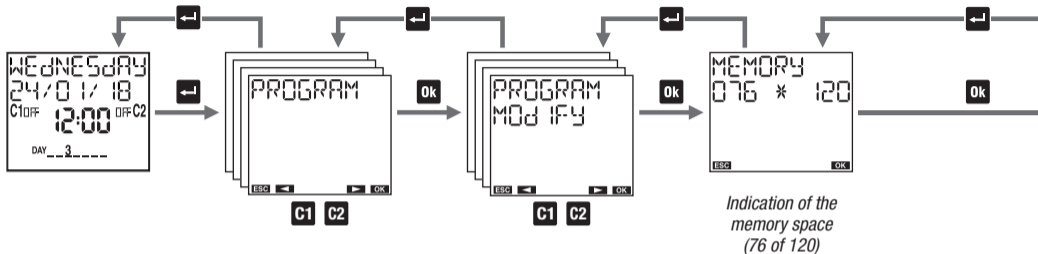

How to modify or to delete a program

- ① choose the channel (only for memo DW2, memo Y2).
- ② choose the period: daily, weekly, yearly, holiday
- ③ choose the type: on/off, on pulse, off pulse

Note: a program requires more screens to be displayed:

- press the key **Ok** to move from the first to the second part of the same program
- press the keys **C1** and **C2** key to switch from one program to another

To modify: press for a long time (at least 3 seconds) the key **Ok**

To delete: press for a long time and simultaneously the keys **Ok** and **↶**

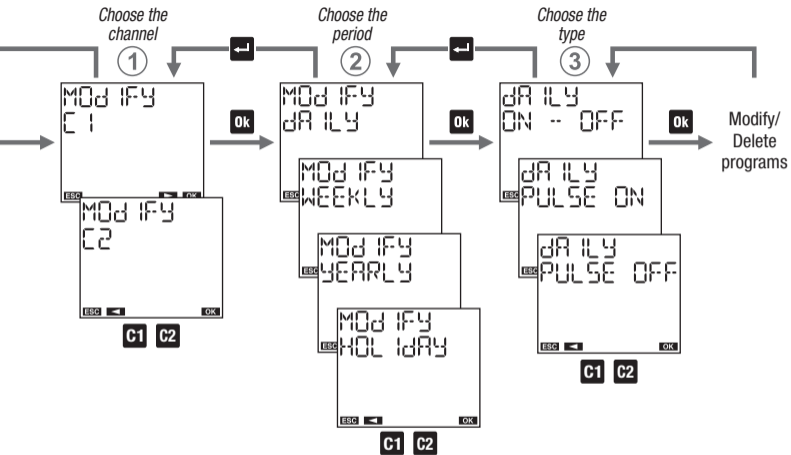

Program menu: copy (only for memo DW2 and memo Y2)

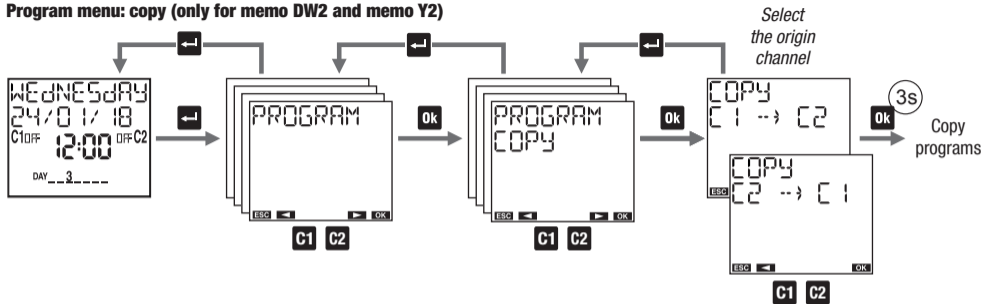

“Copy” menu allows copying the programs of a channel (origin channel) on the other channel (channels destination).
Note: the programs previously stored on the channel destination will be deleted.

Program menu: delete

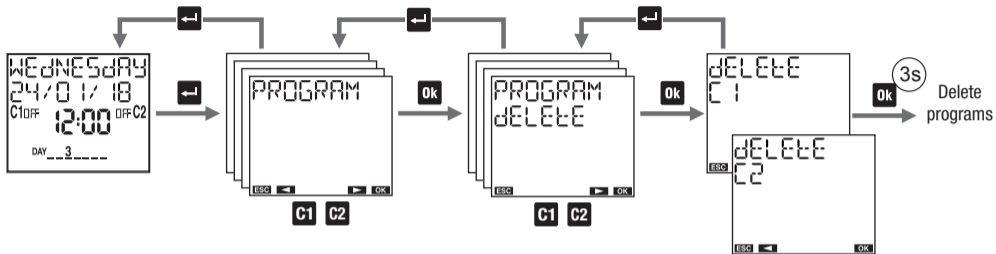

"Delete" menu is used to delete all stored programs on the specified channel.
Note: to delete one single program to see "modify" mode (see page 34).

NFC MENU

The NFC menu allows you to enable or disable the NFC interface.

To enable the NFC interface:

- ① set NFC ON

Warning: to make the NFC interface active, the memo must displays the main page (see page 8).
The NFC interface is therefore not active when browsing through the memo NFC menus.
To guarantee a stable communication, lay the smartphone on memo's display.

To disable the NFC interface:

- ② set NFC OFF

In this way no communication can take place between your device and memo.

The memo works with the settings and programs already set; any changes or creation of new programs must be made by acting directly on the keyboard of memo.

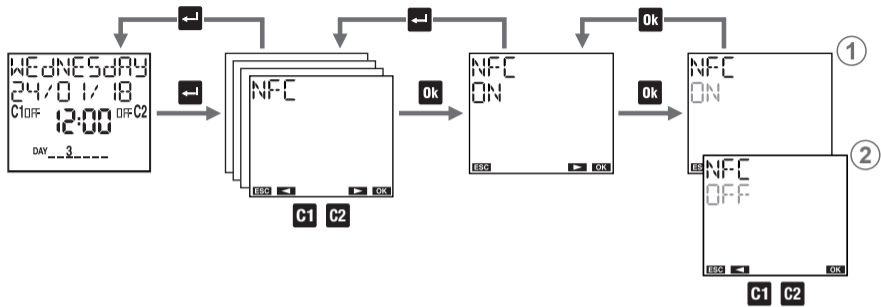

HOUR COUNTER MENU

“Hour counter” menu allows you to display the hours of use (relay on) of connected loads.

The maximum value of the counter is 99999 hours (about 11 years); reached the maximum limit, the counter resets automatically.

To reset a counter:

1. select the desired channel (only for memo DW2 and memo Y2)

2. press the key **OK** for 3 seconds until the display shows “HOUR CNE DELETE ?”

3. confirm by pressing **OK** (press **↵** to exit without zeroing)

Note: it's possible to reset all counters contemporary from the “Reset” menu (see page 42).

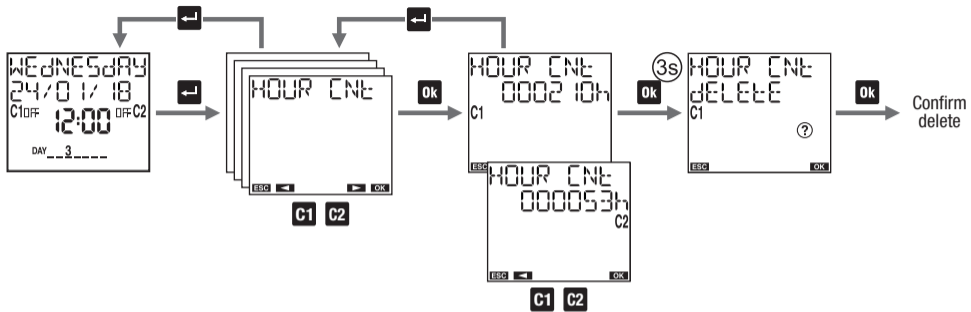

RESET MENU

“Reset” menu allows you to restore the initial state of the device.

Available resets:

- ① Settings reset: deletes all the carried out settings (except the language and the PIN)
- ② Time programs reset: deletes all saved time programs
- ③ Holiday programs reset: deletes all saved holiday programs
- ④ Counter reset: resets the counters of all channels
- ⑤ Reset all: carries out all the above described resets and deletes the language and PIN protection

There is also another reset, of hardware type, which allows you to reset the device in case it responds to the pressing of the keys so unexpectedly, without losing the carried out settings/programs (only the date and the time are lost).

To carry out a hardware reset:

1. press the key “R” with a sharp object



The hardware reset is also useful when you forget PIN protection. Reset, in fact, unlocks the keyboard for 3 minutes, the necessary time to access the appropriate menu and check/disable PIN.

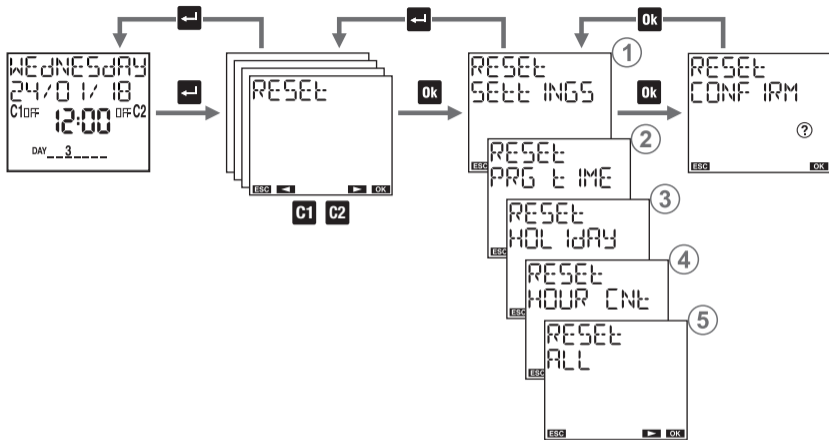

FIRMWARE MENU

This menu shows the firmware installed in the device, where:

022 is the revision index

05 is the month

20 is the day

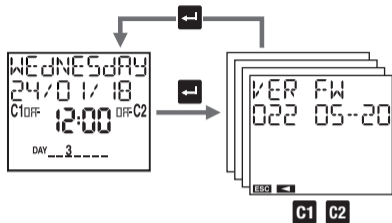

ERROR SIGNALS

When setting up programs, in case of a discrepancy, the following error messages can occur:

- ERROR 001 on and off events with different frequency (each on event must have an off event)
- ERROR 002 on and off concomitant events of the same program
- ERROR 003 Two or more consecutive on events of the same program / Two or more consecutive off events of the same program
- ERROR 004 Invalid date
- ERROR 005 Insufficient memory
- ERROR 006 Attempt to set an on pulse on a channel where is already stored an off pulse (see page 25)
- ERROR 007 Attempt to set an off pulse on a channel where is already stored an on impulse (see page 25)
- ERROR 008 Attempt to set an on holiday program on a channel where is already stored an off holiday program (see page 30)
- ERROR 009 Attempt to set a holiday off program on a channel where a holiday on program is already stored (see page 30)

ERROR 010 Attempt to set a holiday program of on and off events on different days of the week (see page 31)

ERROR 030 Error accessing memory *

* In this case, carry out a hardware reset (see page 42).
If the error persists, contact Vemer technical support (tel.+ 39.0439.879885).

BATTERY MANAGEMENT

When the battery is close to empty, on the first line of the display appears 𐄂𐄃𐄄𐄅𐄆𐄇. In this case, the battery must be replaced as soon as possible. **Use only batteries of CR2032.**

To replace the battery:

- disconnect the mains
- remove the battery slot cover, turning it anti-clockwise
- replace the battery and remount the cover, turning it clockwise
- connect the power supply

Warning: do not use metal objects (such as screwdrivers) to remove the battery because this may cause the power reserve to be canceled, resulting in a loss of date and time.

Warning: in order not to lose date and hour set, it is necessary to ensure that the time for the battery replacement doesn't exceed 60 seconds (in absence of power by means).



Dispose of the used batteries observing the laws in force in relation to the disposal of hazardous waste.

REFERENCE STANDARDS

Compliance with Community Directives:

2014/35/EU (LVD)

2014/30/EU (EMCD)

is declared in reference to the harmonized Standards

- EN 60730-2-7

Energy Conservation Solutions Pty Ltd

Exclusive Distributor for **VEMER** in Australia

Locations: VIC/TAS, NSW, QLD, ACT, SA/NT & WA

Phone: **1300 306 136**

For contact details visit: **www.ecs.net.au**



Vemer S.p.A.

I - 32032 Feltre (BL) • Via Camp Lonc, 16
Tel +39 0439 80638 • Fax +39 0439 80619
e-mail: info@vemer.it - web site: www.vemer.it