

INTERRUTTORE ORARIO DIGITALE

Manuale d'Uso

memo DW E

Digital time switch: User Manual



CE

Vemer
SPA

Index

■ Technical features	page	3		
■ Safety warnings	page	4		
■ Dimensions	page	4		
■ Wiring diagrams	page	5		
■ Display and keyboard description	page	6		
■ Initial operation	page	7		
■ Start page (or main)	page	8		
■ Menu description	page	9		
■ Settings menu	page	10		
Language setting menu	page	11		
Date setting menu	page	12		
Time setting menu	page	13		
Daylight saving time (DST)/winter time (CET) change setting menu	page	14		
Random switchings setting menu	page	16		
Protection PIN setting menu	page	17		
■ Program menu	page	18		
Program menu: new	page	23		
Program menu: new daily timed	page	24		
Program menu: new weekly timed	page	25		
Program menu: new holiday timed	page	26		
Program menu: check	page	28		
Program menu: modify	page	30		
Program menu: delete	page	32		
			■ Hour counter menu	page 33
			■ Reset menu	page 34
			■ Firmware menu	page 36
			■ Error signals	page 37
			■ Battery management	page 38
			■ Reference standards	page 38

USER MANUAL

The digital time switches of memo series are electronic devices for the management of the electrical utilities over time. They allow the time programming (periodicity: daily, weekly).

The backup battery allows you to keep the settings even in case of black-out and can be replaced through the cover on the back of the time switch.

The time switches of Memo series are devices that perform actions of 1B type , intended to operate in environments with III overvoltage category and pollution degree 2 in accordance with EN 60730-1 standard.

Code	Model	Description
VP871800	memo DW E	Daily/weekly time switch 1 channel 230V AC
VE462800	memo DW E 12V	Daily/weekly time switch 1 channel 12V AC/DC
VE463600	memo DW E 24V	Daily/weekly time switch 1 channel 24V AC/DC

TECHNICAL FEATURES

- Power supply:
 - **memo DW E:** 230V AC (-15% ÷ +10%) 50/60 Hz
 - **memo DW E 12V:** 12V AC/DC ($\pm 15\%$) 50/60 Hz (AC)
 - **memo DW E 24V:** 24V AC/DC ($\pm 15\%$) 50/60 Hz (AC)
- Power consumption:
 - **memo DW E:** 1W (3,5 VA)
 - **memo DW E 12V:** 1W (1 VA)
 - **memo DW E 24V:** 1,5W (2 VA)
- Lithium backup battery: 3V, CR2032 type (replaceable)
- Output: 1 monostable change-over relay with maximum switchable load of 16A / 250V
- Terminal block for cables with maximum cables section of 2.5 mm²
- Display LCD with backlighting (active with AC power supply)
- Storable programs: 120 events
- Actions type: 1B
- Operating temperature: -20°C ÷ 50°C
- Operating humidity: 20 ÷ 90% non condensing
- Storage temperature: -10 ÷ + 70°C
- Container: 2 DIN modules
- Protection degree: IP20
- Insulation: reinforced between accessible parts (front) and all the other terminals

SAFETY WARNINGS

■ ***During product installation and operation it is necessary to observe the following instructions:***

- 1) The instrument must be installed by a qualified person, strictly in observance of the connection diagrams shown in this manual.***
- 2) After installation inaccessibility to the terminals without using dedicated tools must be guaranteed.***
- 3) Before accessing the connection terminals, make sure that the leads are not live.***
- 4) Do not connect or feed the instrument if any part of it is damaged.***
- 5) The product must be installed and activated in compliance with current electric systems standards.***
- 6) Do not use the product for anything other than the indicated purpose.***
- 7) In the electrical system upstream of the device must be installed a protection device against the overcurrents***
- 8) The product can be used in environments with Measurement Category III and Pollution degree 2, according to the Standard EN 60730-1***

DIMENSIONS

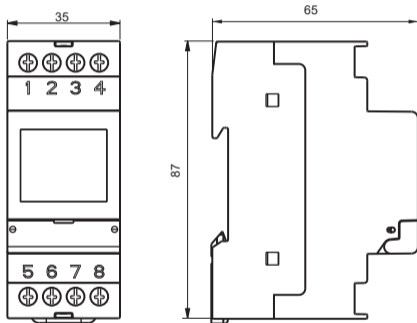

WIRING DIAGRAMS

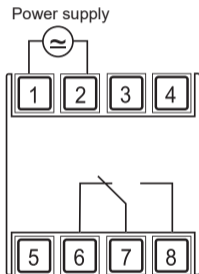

DISPLAY AND KEYBOARD DESCRIPTION

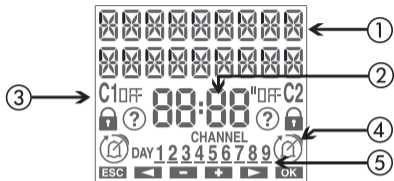

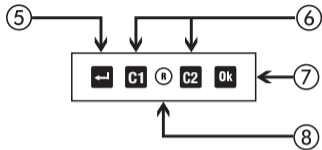

- ① General indications
- ② Time indication
- ③ Channel 1 status indication
 - _n / OFF channel status
 - 🔒 blocked switchings
 - ❓ active random switchings
 - active holiday program
 - 🔔 active pulse program
 - 🕒 active manual program
- ④ Day of the week (DAY) indication



- ⑤ Turn on the display
Access the menu
ESC (one level back)
- ⑥ Key "C1": decrease datum/previous menu/ switching channel
1/lock channel 1
Key "C2": increase datum/next menu
- ⑦ Confirm selection
- ⑧ Hardware reset

Key "OK" + "C1" (3 sec): random switching channel 1

INITIAL OPERATION

- Once out of the package, memo is off: press the key  and wait a moment before activating the display
- The set language is Italian. To change it, press the key  for at least 3 seconds. Choose among: Italian, English, Spanish, French or German and confirm with 
- Make connections following the diagrams on page 5 of this manual
- Power memo: the backlighting turns on permanently.
- The presence of the backup battery allows the memo to have updated date and time.
To make the other settings follow the following steps:

Date	- format: DD/MM/YY - 1 st day of the week: Monday
------	---

Daylight Saving time (DST) change: active	- start of daylight saving time (DST): last Sunday of March at 02:00 o'clock - end of daylight saving time (DST): last Sunday of October at 03:00 o'clock
---	--

Random switchings:	- minimum: 1 minute - maximum: 5 minutes
--------------------	---

Keypad lock with PIN:	disabled (---)
-----------------------	----------------

START PAGE (or main)

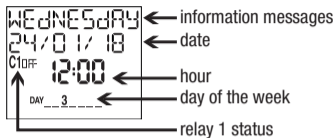

Information messages

- day of the week
- battery status (only if discharged)
- NO SUPPLY*

* Only if memo is not powered by mains.

In this condition the backlighting is not active and the relay is in off status.

- Press the key

← to access the menu of memo

C1 to change channel 1 status

MENU DESCRIPTION

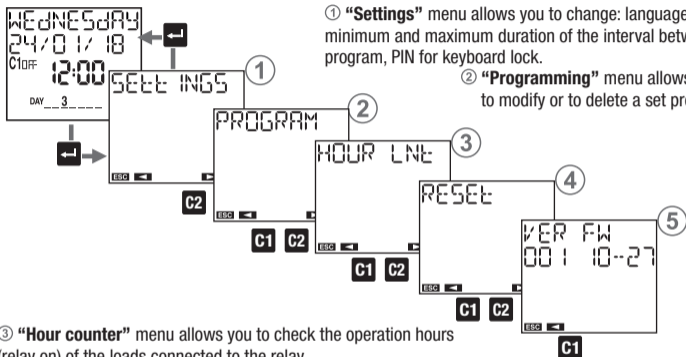

① "Settings" menu allows you to change: language, date, time, daylight saving time (DST), minimum and maximum duration of the interval between two switchings with random program, PIN for keyboard lock.

② "Programming" menu allows you to set a new program or to check, to modify or to delete a set program.

③ "Hour counter" menu allows you to check the operation hours (relay on) of the loads connected to the relay.

④ "Reset" menu allows you to reset settings, programmed settings, operating hour counter.

⑤ "Ver FW" menu allows you to check the firmware version installed on the device.

SETTINGS MENU

“Settings” menu allows you to view and eventually to modify the general operation settings of memo, such as:

- ① language
- ② date
- ③ time
- ④ automatic daylight saving time (DST) change
- ⑤ position (astronomical coordinates)
- ⑥ interval duration between two random switchings
- ⑦ keys protection by PIN

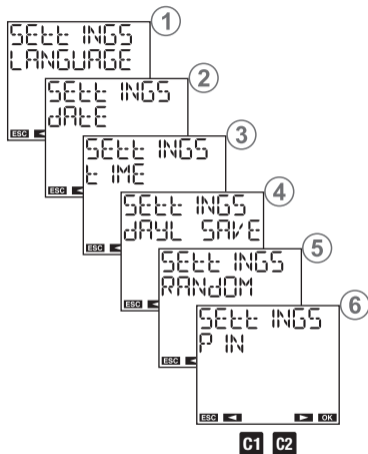

Language setting menu

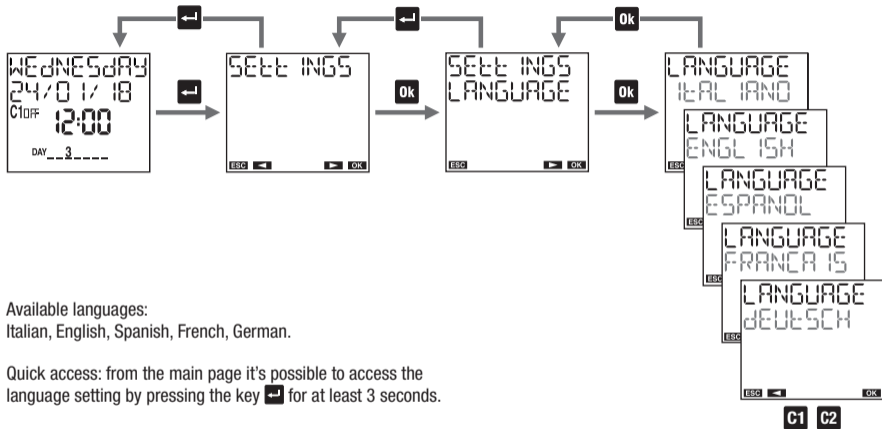

Available languages:

Italian, English, Spanish, French, German.

Quick access: from the main page it's possible to access the language setting by pressing the key **↓** for at least 3 seconds.

Date setting menu

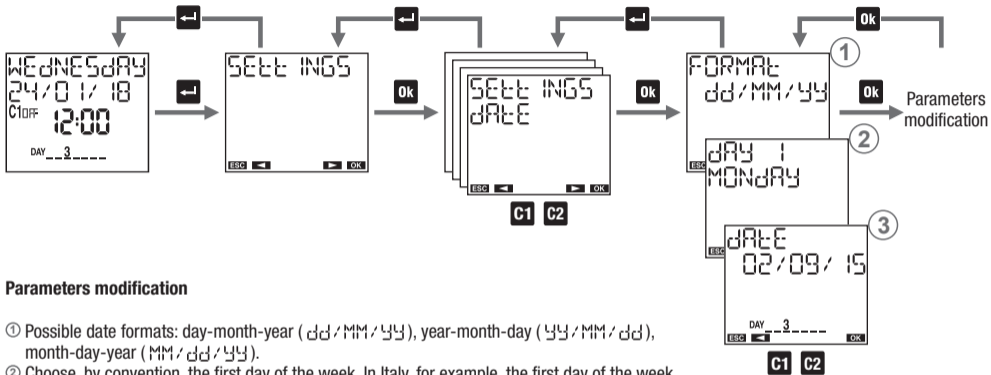

Parameters modification

- ① Possible date formats: day-month-year (dd/MM/yy), year-month-day (yy/MM/dd), month-day-year (MM/dd/yy).
- ② Choose, by convention, the first day of the week. In Italy, for example, the first day of the week is Monday, in the UK it's Sunday.
- ③ Enter the date: day, month, year.

Time setting menu

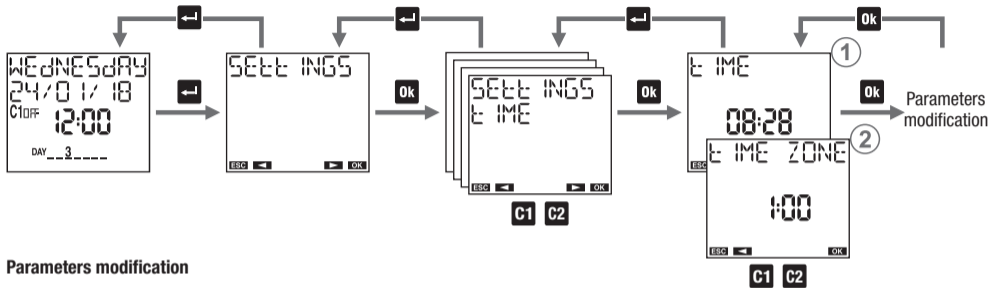

Parameters modification

Set the time: hours, minutes.

Daylight saving time (DST)/winter time (CET) change setting menu

Daylight saving time (DST)/winter time (CET) change and vice versa can occur in an automatic way. In this case, memo:

- increases by an hour in the passage from winter time (CET) to daylight saving time (DST)
- decreases by an hour in the passage from daylight saving time (DST) to winter time (CET)

For every change it's necessary to specify:



the week of the month during which the time change occurs (first, second, third, fourth, last)



the day of the week (Monday: 1, Tuesday: 2, ...)



the month



the hour and the minutes

In Italy, for example, daylight saving time (DST) begins occurs the last (LAST) Sunday (7) of March (03) at 02:00 o'clock, and ends the last (LAST) Sunday (7) of October (10) at 03:00 o'clock.

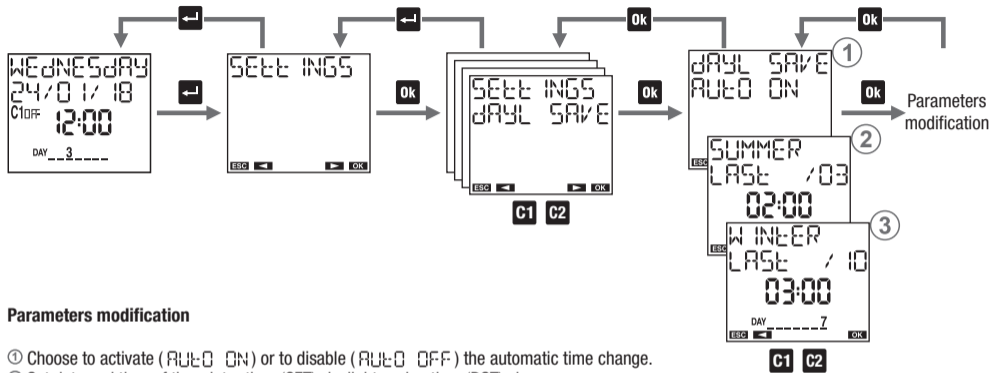

Parameters modification

- ① Choose to activate (AUTO ON) or to disable (AUTO OFF) the automatic time change.
- ② Set date and time of the winter time (CET)-daylight saving time (DST) change.
- ③ Set date and time of the daylight saving time (DST)-winter time (CET) change.

Random switchings setting menu

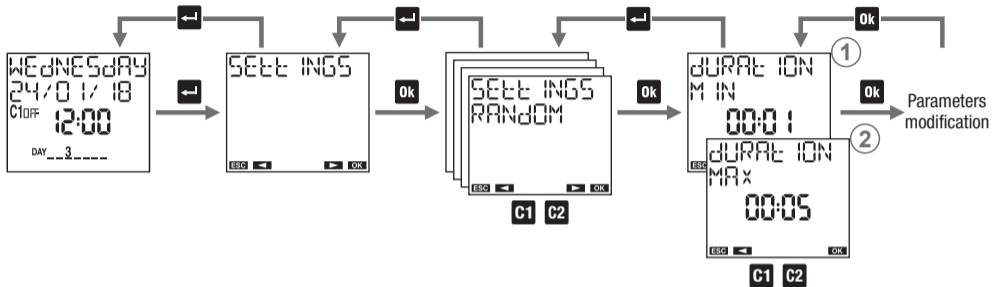

The “random switching ②” function (activated with the combination described on page 6) allows the channel to automatically switch and at random time intervals.

In this menu it's possible to define the minimum and maximum duration of the time interval between two random switchings. Default minimum duration is 1 minute, maximum duration is 5 minutes.

Parameters modification

① Set the minimum duration. It's possible to set values between 1 minute and the *maximum duration*.

② Set the maximum duration. It's possible to set values between the *minimum duration* and 23:59 hours.

Note: setting the minimum duration equal to the maximum, the switchings will occur at fixed time intervals.

Protection PIN setting menu

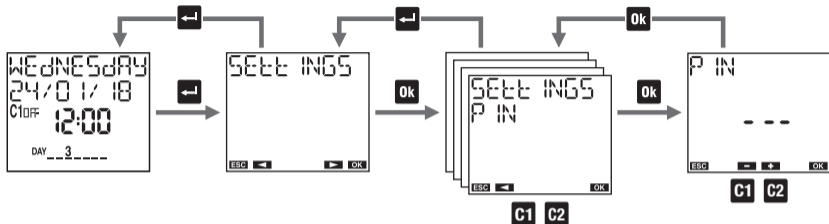

The protection code (PIN) is used to lock the keyboard and prevent changes by unauthorized persons. With active PIN protection, pressing any key, it's necessary to enter the PIN: if PIN is correct the keyboard unlocks; after 3 minutes without pressing a key, the keyboard will lock automatically.

To activate PIN protection:

- set a value between 000 and 999

To disable PIN protection:

- set "---" (located before 000 or after 999)

Note: If you have forgotten your PIN code to unlock memo it's necessary to carry out a hardware reset (see page 34).

PROGRAM MENU

The menu “program” allows you to:

- ① create a new program
- ② check created programs
- ③ change or delete a created program
- ④ delete all programs of a channel

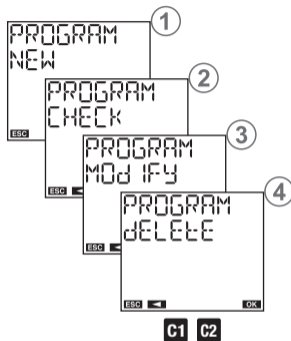

Select days

scroll through the days of the week from 1 to 7:

- by pressing the key **C2** to move to the next day without selecting the current day
- by pressing the key **Ok** to select/deselect the current day and move to the next

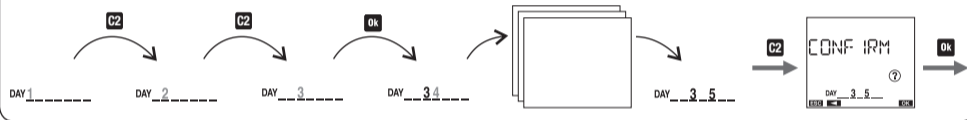

Programs types

- Program ON/OFF: is composed of a switching of the ON relay and of a subsequent switching of the OFF relay. It can have a daily period (everyday with the same modes), weekly (every week with the same modes).
 - PULSE ON program: is an ON relay switching for a maximum duration of 59 seconds. It can have a daily period (everyday with the same modes), weekly (every week with the same modes).
 - PULSE OFF program: is a relay switching OFF for a maximum duration of 59 seconds. It can have daily period (everyday with the same modes), weekly (every week with the same modes).
 - HOLIDAY program: is a period of time defined by a start time and an end time within which all programmed switchings are disabled. The relay is in OFF position (OFF holiday) or in ON position (ON holiday).
- ⚠ **Important:** on the channel can't coexist ON pulses and OFF pulses (if an ON pulse is already present, it's not possible to save a holiday OFF and vice versa).
- ⚠ **Important:** on the channel can't coexist holiday ON programs and holiday OFF programs (if a holiday ON program is already present, it's not possible to save a holiday OFF program and vice versa).

Programs priority

The priority programs defines how memo manages the case in which programs with different period are running at the same time (1 indicates higher priority).

Program	Date*	Yearly	Monthly	Weekly	Daily
Holiday	1				
Pulse				2	3
On/Off				4	5

* Date: select day, month, year (program carried "only once in the life of the product"). If the month is not specified, the program is carried out all days *xx* of all months of the specified year.

Priority list on/off

In case in which, on the same channel, on/off programs are provided with different period (daily, weekly) to carry out in the same day, only the program with the highest priority is executed.

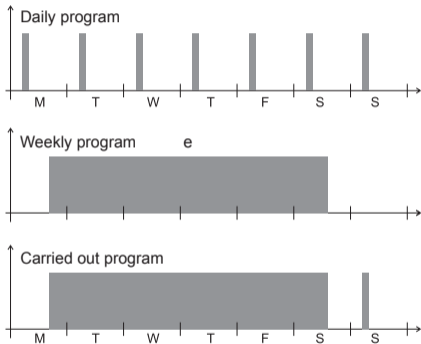

From this example it's possible to see that the daily event on Monday is not carried out because in the same day it is provided the beginning of the week program (even if the daily program

of Monday begins and ends before the beginning of the weekly program). Instead, the daily program of Sunday is carried out because it's the only one running for that day.

Holiday program

The holiday program just begins and ends exactly at the specified times.

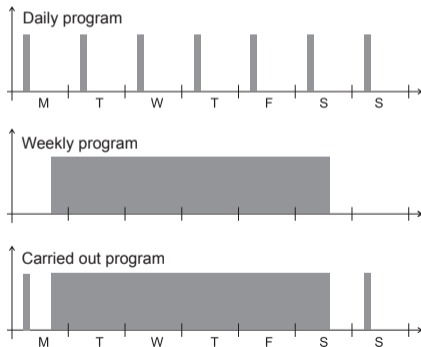

Program menu: new

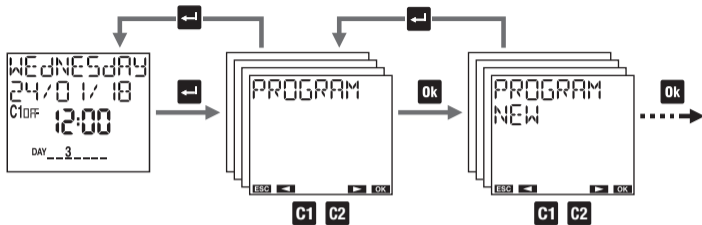

Program menu: new holiday time

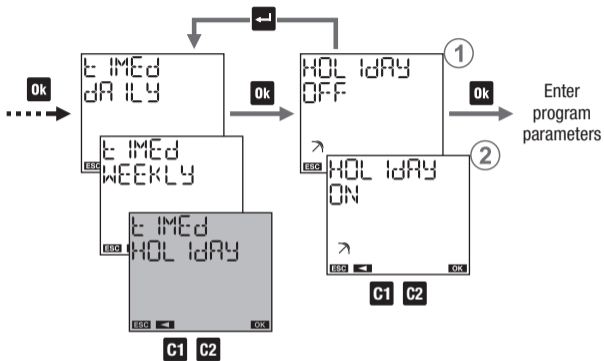

- ① HOLIDAY OFF: the relay is OFF from the beginning to the end of holiday program.
- ② HOLIDAY ON: the relay is ON from the beginning to the end of holiday program

Program parameters

- beginning of the program
- end of the program

How to choose the day (or days) in a holiday astro program



① to set the program:

in the first, second, third, fourth or last week of the month
 in / the day/s (Monday, ...) of the week just specified
 the specified month (MM for all months)
 the given year (YY for all years)

Note: in this case, the holiday program must begin and end in the same day. Otherwise ERROR □ □ is signaled.

② to set the program on the last day:

--- /MM /YY of all months of all years
 --- /VV /YY of the specified VV month of all years
 --- /MM /ZZ of all months of the specified ZZ year
 --- /VV /ZZ of the specified VV month of the specified ZZ year

③ to set the program on the day XX (1,2,3...):

xx /MM /YY of all months of all years
 xx /VV /YY of the specified VV month of all years
 xx /MM /ZZ of all months of the specified ZZ year
 xx /VV /ZZ of the specified VV month of the specified ZZ year

Program menu: check

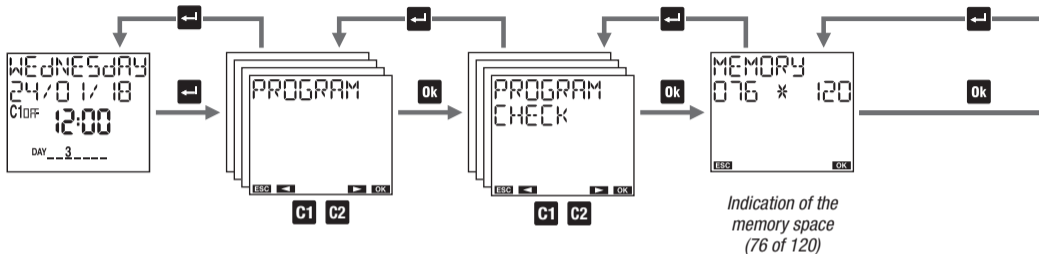

How to check a program

- ① choose the period: daily, weekly, holiday
- ② choose the type: on/off, on pulse, off pulse

Note: a program requires more screens to be displayed:

- press the key **Ok** to move from the first to the second part of the same program
- press the keys **C1** and **C2** to switch from one program to another

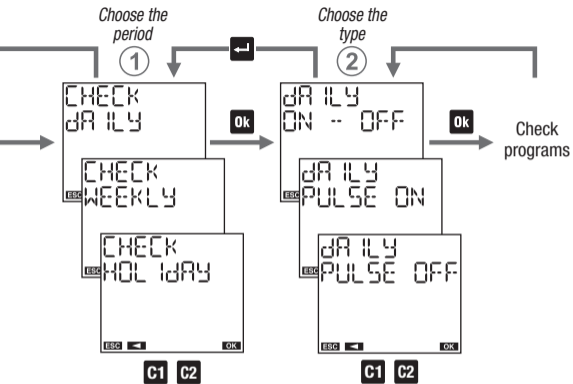

Program menu: modify

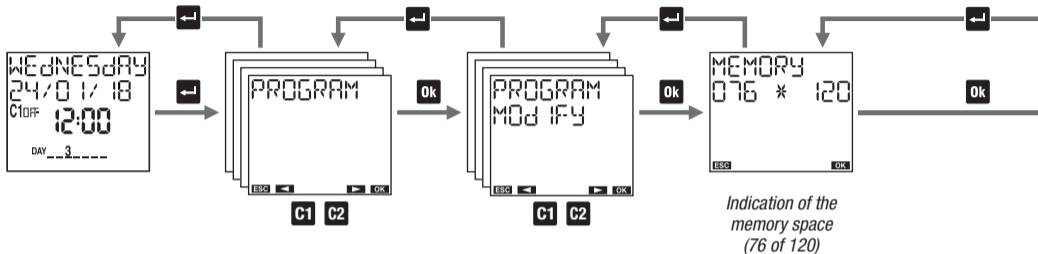

How to modify or to delete a program

- ① choose the period: daily, weekly, holiday
- ② choose the type: on/off, on pulse, off pulse

Note: a program requires more screens to be displayed:

- press the key **Ok** to move from the first to the second part of the same program
- press the keys **C1** and **C2** key to switch from one program to another

To modify: press for a long time (at least 3 seconds) the key **Ok**

To delete: press for a long time and simultaneously the keys **Ok** and **←**

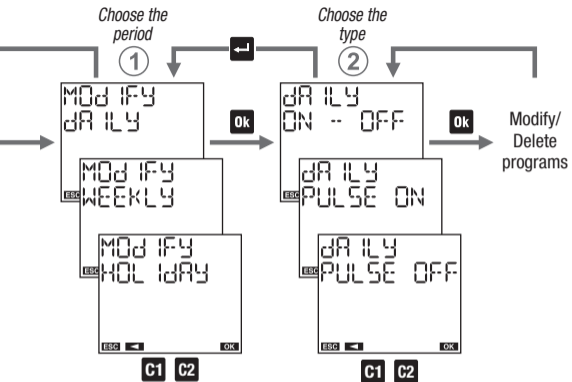

Program menu: delete

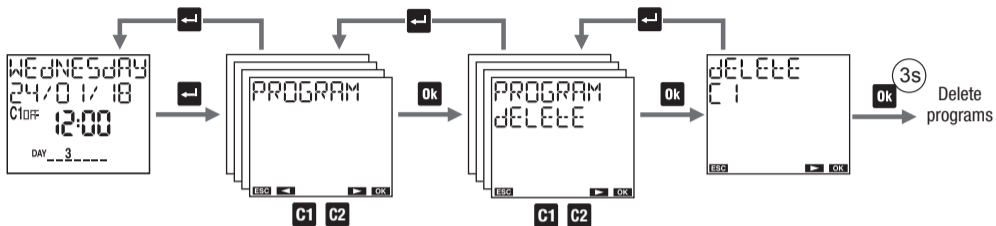

"Delete" menu is used to delete all stored programs.

Note: to delete one single program to see "modify" mode (see page 30).

HOUR COUNTER MENU

“Hour counter” menu allows you to display the hours of use (relay on) of connected loads.

The maximum value of the counter is 99999 hours (about 11 years); reached the maximum limit, the counter resets automatically.

To reset a counter:

1. press the key **Ok** for 3 seconds until the display shows “**HOUR CNT DELETE ?**”
2. confirm by pressing **Ok** (press **ESC** to exit without zeroing)

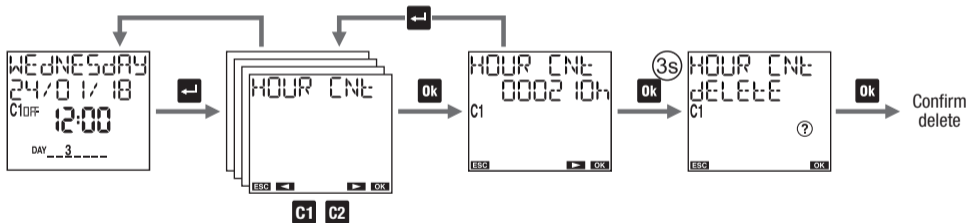

RESET MENU

“Reset” menu allows you to restore the initial state of the device.

Available resets:

- ① Settings reset: deletes all the carried out settings (except the language and the PIN)
- ② Time programs reset: deletes all saved time programs
- ③ Holiday programs reset: deletes all saved holiday programs
- ④ Counter reset: resets the counter of the channel
- ⑤ Reset all: carries out all the above described resets and deletes the language and PIN protection

There is also another reset, of hardware type, which allows you to reset the device in case it responds to the pressing of the keys so unexpectedly, without losing the carried out settings/programs (only the date and the time are lost).

To carry out a hardware reset:

1. press the key “R” with a sharp object



The hardware reset is also useful when you forget PIN protection. Reset, in fact, unlocks the keyboard for 3 minutes, the necessary time to access the appropriate menu and check/disable PIN.

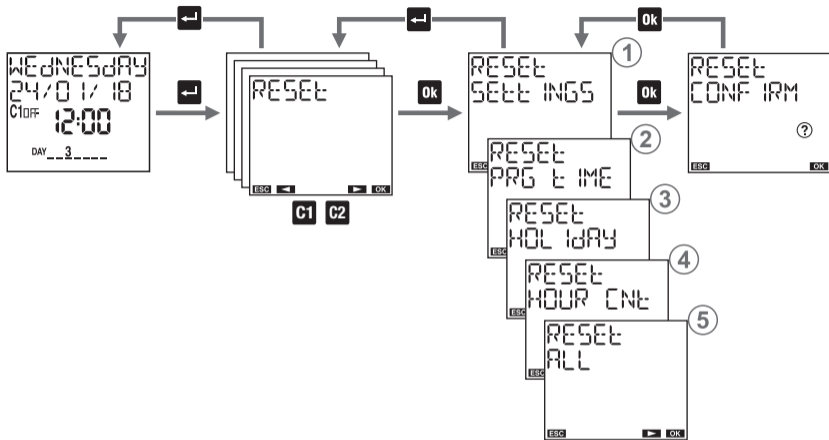

FIRMWARE MENU

This menu shows the firmware installed in the device, where:

022 is the revision index

05 is the month

20 is the day

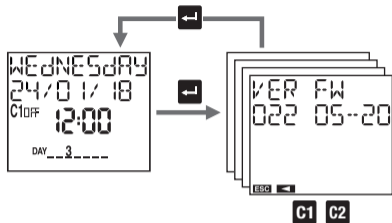

ERROR SIGNALS

When setting up programs, in case of a discrepancy, the following error messages can occur:

- ERROR 001 on and off events with different frequency (each on event must have an off event)
- ERROR 002 on and off concomitant events of the same program
- ERROR 003 Two or more consecutive on events of the same program / Two or more consecutive off events of the same program
- ERROR 004 Invalid date
- ERROR 005 Insufficient memory
- ERROR 006 Attempt to set an on pulse on a channel when is already stored an off pulse (see page 22)
- ERROR 007 Attempt to set an off pulse on a channel when is already stored an on impulse (see page 22)
- ERROR 008 Attempt to set an on holiday program on a channel when is already stored an off holiday program (see page 26)
- ERROR 009 Attempt to set a holiday off program on a channel when a holiday on program is already stored (see page 26)

ERROR 010 Attempt to set a holiday program of on and off events on different days of the week (see page 27)

ERROR 030 Error accessing memory *

* In this case, carry out a hardware reset (see page 34).
If the error persists, contact Vemer technical support (tel.+ 39.0439.879885).

BATTERY MANAGEMENT

When the battery is close to empty, on the first line of the display appears 𐄂𐄂𐄂𐄂𐄂𐄂. In this case, the battery must be replaced as soon as possible. **Use only batteries of CR2032.**

To replace the battery:

- disconnect the mains
- remove the battery slot cover, turning it anti-clockwise
- replace the battery and remount the cover, turning it clockwise
- connect the power supply

Warning: do not use metal objects (such as screwdrivers) to remove the battery because this may cause the power reserve to be canceled, resulting in a loss of date and time.

Warning: in order not to lose date and hour set, it is necessary to ensure that the time for the battery replacement doesn't exceed 60 seconds (in absence of power by means).



Dispose of the used batteries observing the laws in force in relation to the disposal of hazardous waste.

REFERENCE STANDARDS

Compliance with Community Directives:

2014/35/EU (LVD)

2014/30/EU (EMCD)

is declared in reference to the harmonized Standards

- EN 60730-2-7

Energy Conservation Solutions Pty Ltd

Exclusive Distributor for **VEMER** in Australia

Locations: VIC/TAS, NSW, QLD, ACT, SA/NT & WA

Phone: **1300 306 136**

For contact details visit: **www.ecs.net.au**



Vemer S.p.A.

I - 32032 Feltre (BL) • Via Camp Lonc, 16
Tel +39 0439 80638 • Fax +39 0439 80619
e-mail: info@vemer.it - web site: www.vemer.it