

DATA SHEET

AFL SUN LED 10W 5K white

Order description

AFL SUN LED 10 W 5K WH

Item number

EL10810077

GTIN

4015120810077

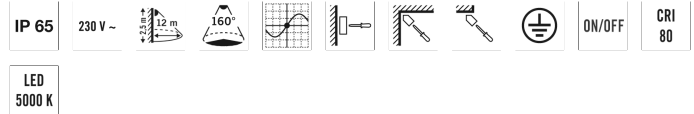

Product description

- LED floodlight with high-grade die-cast aluminium housing and integrated motion detector with 160° field of detection for convenient lighting control
- 10 W LED luminous efficiency corresponds to 63 W light bulb, light colour approx. 5000 K white
- High light yield of 90 lm/W, excellent colour rendering index Ra 80

Technical data

GENERAL	
Conformity	CE, RoHS, WEEE
warranty	3-year
MOUNTING	
Installation type	Surface mounting
Mounting location	Wall
HOUSING	
Dimensions	Length 210 mm x Width 133 mm x Height/Depth 75 mm
Weight	692 g
Material	Aluminium and UV-stabilised plastic
Protection type	IP 65
Permissible ambient temperature	-25 °C...+40 °C
Colour	white, similar to RAL 9016
Terminal	2,5 mm ² / 1,5 mm ²
ELECTRICAL VERSION	
Protection class	I
Nominal voltage	230 - 230 V / 50 Hz
Stand-by consumption	0.5 W

LIGHT	
Diffusor	transparent
Light emission	direkt
Beam angle	95 °
Flicker factor	<20 %
Rated output	9 W
Luminous Flux (light)	1020 lm
Luminous efficacy	113 lm/W
LED service life	L80B50 = 50.000 h
Colour temperature	5000 K
Colour rendering index Ra	> 80
Energy efficiency class	A++ to A
SENSORS	
Detection angle	160°
Detection range diagonally	12 m
Field of detection	50 m ²
Range adjustment	mechanically with included cut to size lens mask
Recommended installation height	2,5 m
Max. mounting height	4 m
Number of parallel switchable detectors	10

DATA SHEET

AFL SUN LED 10W 5K white

Order description	Item number	GTIN
AFL SUN LED 10 W 5K WH	EL10810077	4015120810077

Accessories

Product designation	Item number	GTIN
Wall Arm 700 WH	EL10810527	4015120810527
Ground Spike WH	EL10810541	4015120810541

Scale drawing

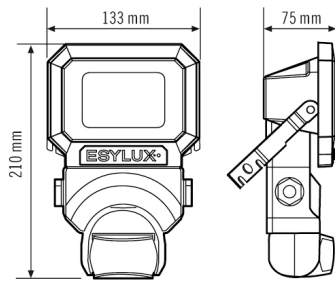

Field of detection

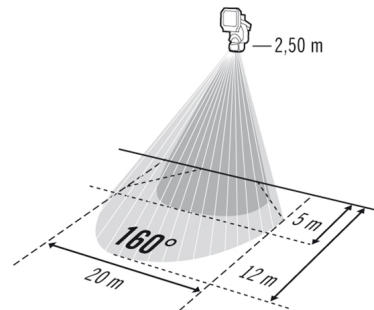

- Head-on to detector
- Passage area / diagonally to detector

Light distribution

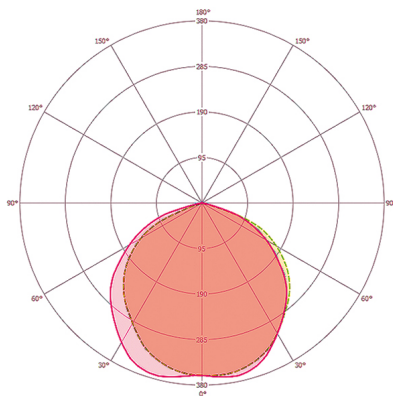

Energy Conservation Solutions Pty Ltd

Exclusive Distributor for ESYLUX in Australia Locations:

VIC/TAS, NSW, QLD, ACT, SA/NT & WA

Phone: 1300 306 136

For contact details visit: www.ecs.net.au