

## DATA SHEET

### Order description

IDLELS07020840WH00000000

### Item number

E010300059

### GTIN

4015120300059

110 V - 230 V ~	IP 40	CQS 80 - 85	CRI 80	LED 4000 K
--------------------	-------	----------------	-----------	---------------



### Product description

- LED downlight, 4000K with opal cover (diffuser), 18W, for ceiling mounting without additional accessories
- High light quality and system performance
- Operating device on/off, included

### Technical data

GENERAL	
Conformity	CE, RoHS, WEEE
warranty	5-year
MOUNTING	
Installation type	Recessed mounting
Mounting location	Ceiling
Installation dimension	Installation depth 27 mm, Ø 225 mm
HOUSING	
Dimensions	Height/Depth 27 mm, Ø 240 mm
Weight	812 g
Material	powder-coated aluminium
Protection type	IP 40 / IP 44 below the ceiling (built-in)
Permissible ambient temperature	-20 °C...+40 °C
Colour	white, similar to RAL 9003
Glow wire test in accordance with IEC 60695-2-10	650 °C - 30 s

ELECTRICAL VERSION	
Protection class	II
Nominal voltage	110 - 240 V / 50 - 60 Hz
LIGHT	
Diffusor	opal
Light emission	direkt
Beam angle	120 °
Unified Glare Rating	≤ 25
Flicker factor	<3 %
Rated output	18 W
Luminous Flux (light)	1600 lm
Luminous efficacy	88 lm/W
LED service life	L80B50 = 35.000 h
Colour temperature	4000 K
Colour rendering index Ra	> 80
Color Quality Scale	> 80
Energy efficiency class	A++ to A

### Accessories

Product designation	Item number	GTIN
Indoor downlight ring 225	E010300264	4015120300264
ELSA 225 Surface Mounting Frame WHITE	E010300899	4015120300899
Indoor downlight cable, 1 m	E010300295	4015120300295

## DATA SHEET

Order description	Item number	GTIN
IDLELS07020840WH00000000	E010300059	4015120300059

### Scale drawing

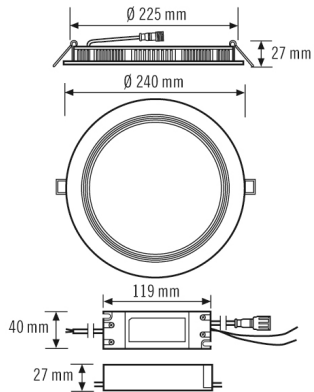

### Light distribution

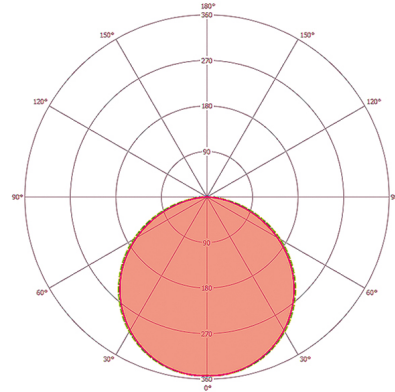

### Circuit diagram

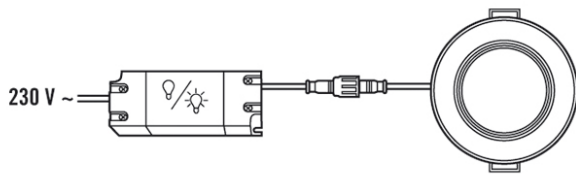

Standard operation

**Energy Conservation Solutions Pty Ltd**  
Exclusive Distributor for ESYLUX in Australia Locations:  
VIC/TAS, NSW, QLD, ACT, SA/NT & WA  
Phone: **1300 306 136**  
For contact details visit: [www.ecs.net.au](http://www.ecs.net.au)