

DATA SHEET

Order description	Item number	GTIN
IDLELS32012840WH00DALI000	E010300431	4015120300431



Product description

- LED down light, 12 W, for recessed ceiling mounting with opal (MILKY) diffuser
- Installation dimensions for recessed ceiling mounting 125x125mm
- Integrated ballast (DALI), installation without further accessories
- High-quality housing, aluminium lamp body, white powder-coated (RAL 9003)
- Colour temperature 4000 K

Technical data

GENERAL	
Conformity	CE, RoHS, WEEE
warranty	5-year
MOUNTING	
Installation type	Recessed mounting
Mounting location	Ceiling
Installation dimension	Installation length 125 mm x Installation width 125 mm x Installation depth 42,5 mm
HOUSING	
Dimensions	Length 145 mm x Width 145 mm x Height/Depth 44,5 mm
Weight	392 g
Material	powder-coated aluminium
Protection type	IP 20 / IP 44 below the ceiling (built-in)
Permissible ambient temperature	-20 °C...+40 °C
Colour	white, similar to RAL 9003
Glow wire test in accordance with IEC 60695-2-10	650 °C - 30 s

ELECTRICAL VERSION	
Protection class	III
Nominal voltage	110 - 240 V / 50 - 60 Hz
LIGHT	
Diffusor	opal
Light emission	direkt
Beam angle	100 °
Unified Glare Rating	≤ 25
Flicker factor	<3 %
Rated output	14 W
Luminous Flux (light)	810 lm
Luminous efficacy	57 lm/W
LED service life	L80B50 = 35.000 h
Colour temperature	4000 K
Colour rendering index Ra	> 80
Colour tolerance	SDCM <3
Color Quality Scale	> 85
Energy efficiency class	A++ to A

DATA SHEET

Order description	Item number	GTIN
IDLELS32012840WHOODALI000	E010300431	4015120300431

Scale drawing

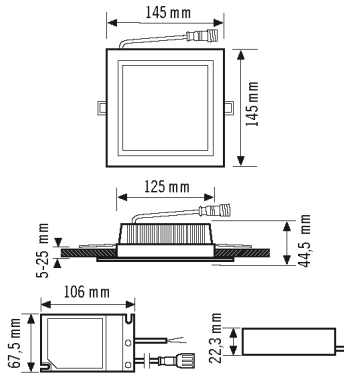

Light distribution

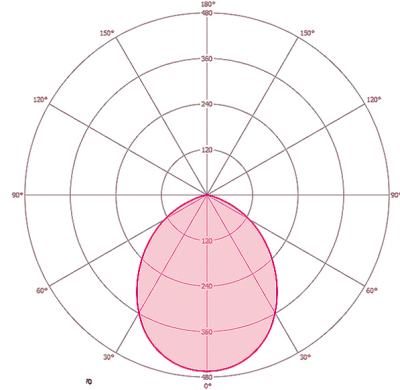

Energy Conservation Solutions Pty Ltd

Exclusive Distributor for ESYLUX in Australia Locations:

VIC/TAS, NSW, QLD, ACT, SA/NT & WA

Phone: **1300 306 136**

For contact details visit: www.ecs.net.au