



Order Code : 3120734
Product Code : SPR 464U 57TF00 16 51K6

Product Data

Standard Features

Housing	: SW 306G painted aluminium injection housing
Diffuser	: Tempered transparent glass
Optic	: 16° lens
IP Grade	: IP66
Installation	: Pole Mounted
Light Source	: Power LED

Optical & Electrical Features

Power Consumption	: 463.5 W
Final Luminous Flux	: 51629.6 lm
Efficacy	: 111.3 lm/W
Input Voltage	: 220-240 V AC
Frequency	: 50-60 Hz
Power Factor	: > 0,9
Surge Transient Protection	: 4 kV
Drive Current	: 1050 mA
Correlated Color Temperature	: 5700K
Color Rendering Index	: >70

Other Features & Conditions

Operating Temperature Range	: -40 °C/+50 °C
Impact Resistance	: IK07
Led Life Time - L70	: > 60.500 hours @Ta= 50 °C

SPRONA

464 W Harbour and Outdoor
LED Area Lighting Luminaire



Photometric Curve

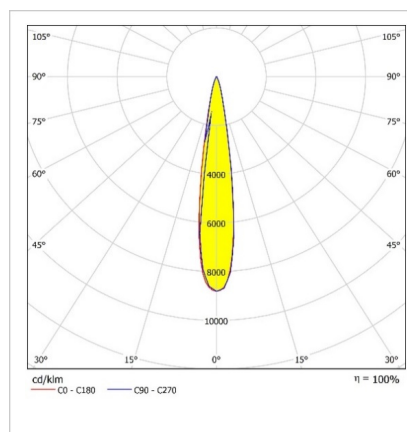

Optional Features

Correlated Color Temperatures	: 4000K, 5000K, 6500K
Angle Options	: 18°, 67°, Asymmetric lens

SPRONA

464 W Harbour and Outdoor LED Area Lighting Luminaire

3120734 SPR 464U 57TF00 16 51K6

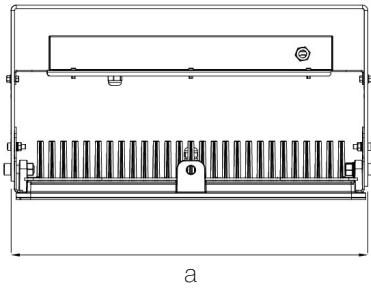

a

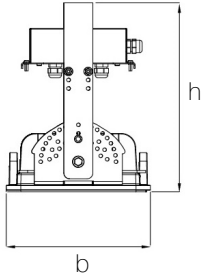

b

Dimensions (mm)

	a	b	h
Single Model	616	249	345
Double Model	616	615	345
Triple Model	616	980	345

Weight (kg)

Single Model	16
Double Model	41
Triple Model	65

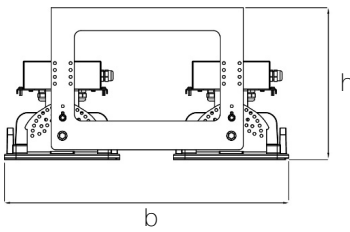

b

Double Model

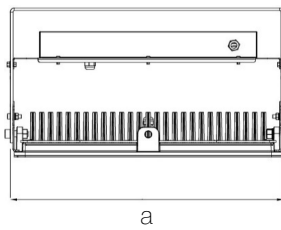

a

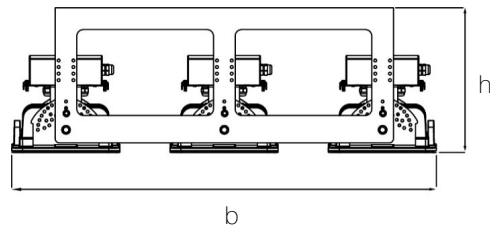

b

Triple Model

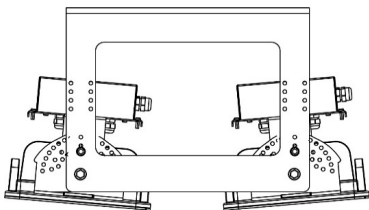

Double Model Movable

90° National position
(In steps of five degrees)

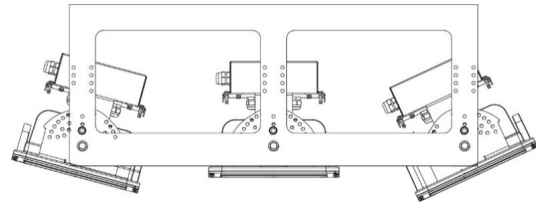

Triple Model Movable

90° National position
(In steps of five degrees)

SPRONA

464 W Harbour and Outdoor LED Area Lighting Luminaire

3120734 SPR 464U 57TF00 16 51K6

Suspension Set

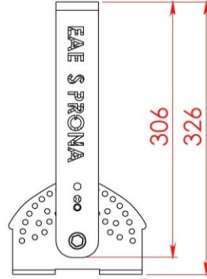
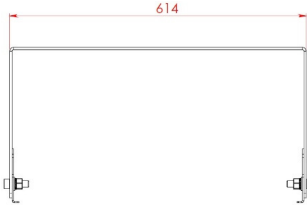

Order Code : 3126252
Product Code : SPR TEKLI ASKI TK

Single Standard Hanger Set

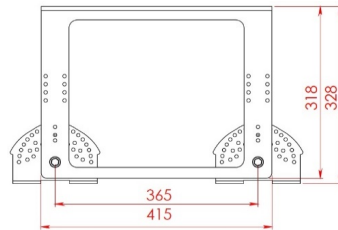
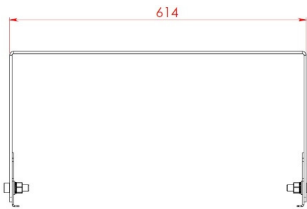

Order Code : 3126251
Product Code : SPR IKILI STD ASKI TK

Double Standard Hanger Set

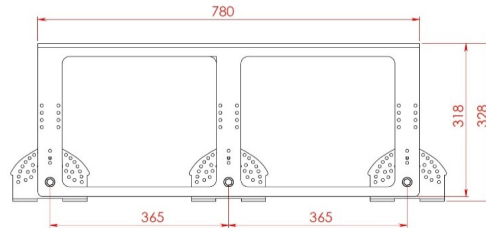
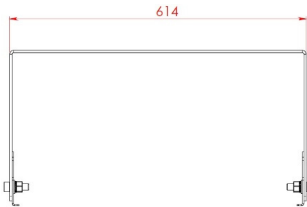

Order Code : 3126255
Product Code : SPR UCLU STD ASKI TK

Triple Standard Hanger Set

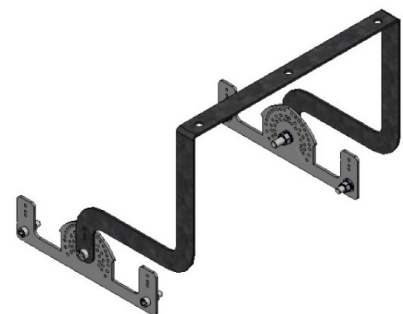
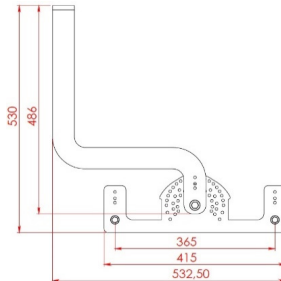
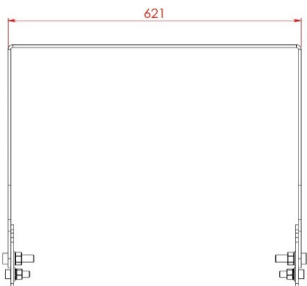

Order Code : 3126250
Product Code : SPR IKILI SEPET ASKI TK

Double Swivel Bracket

SPRONA

464 W Harbour and Outdoor LED Area Lighting Luminaire

3120734 SPR 464U 57TF00 16 51K6

Suspension Set

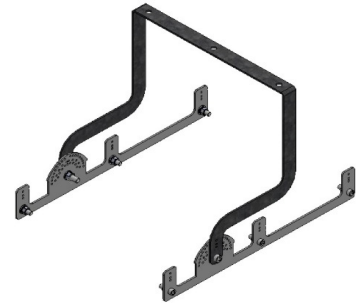
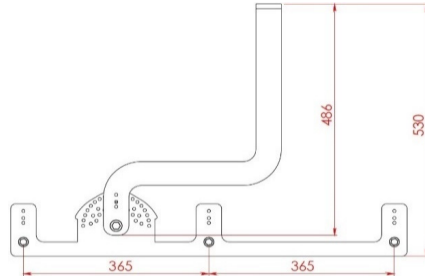
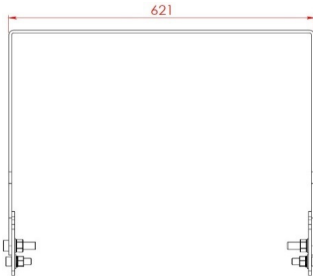

Triple Swivel Bracket

Order Code : 3126254
Product Code : SPR UCLU SEPET ASKI TK

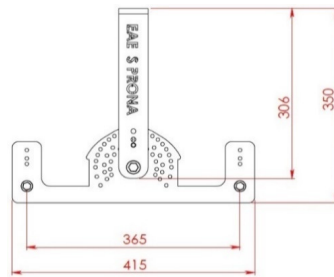

Double Projector Hanger Set

Order Code : 3126249
Product Code : SPR IKILI PROJEKTR ASKI TK

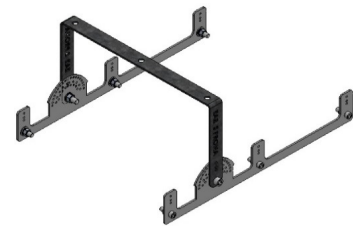
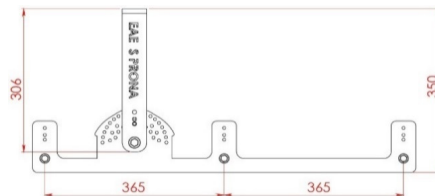
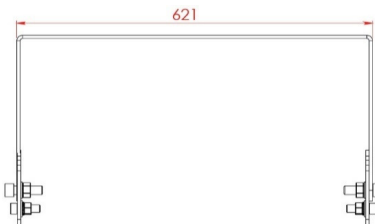

Triple Projector Hanger Set

Order Code : 3126253
Product Code : SPR UCLU PROJEKTR ASKI TK

Energy Conservation Solutions Pty Ltd

Exclusive Distributor for EAE Lighting in Australia
Locations: VIC/TAS, NSW, QLD, ACT, SA/NT & WA

Phone: **1300 306 136**

For contact details visit: www.ecs.net.au