

Order Code : 3120736
Product Code : SPR 453U 57TF00 36 47K7

Product Data

Standard Features

| | |
|--------------|---|
| Housing | : SW 306G painted aluminium injection housing |
| Diffuser | : Tempered transparent glass |
| Optic | : 36° lens |
| IP Grade | : IP66 |
| Installation | : Pole Mounted |
| Light Source | : Power LED |

Optical & Electrical Features

| | |
|------------------------------|----------------|
| Power Consumption | : 453.3 W |
| Final Luminous Flux | : 47778.4 lm |
| Efficacy | : 105.4 lm/W |
| Input Voltage | : 220-240 V AC |
| Frequency | : 50-60 Hz |
| Power Factor | : > 0,9 |
| Surge Transient Protection | : 4 kV |
| Drive Current | : 1050 mA |
| Correlated Color Temperature | : 5700K |
| Color Rendering Index | : >70 |

Other Features & Conditions

| | |
|-----------------------------|-----------------------------|
| Operating Temperature Range | : -40 °C/+50 °C |
| Impact Resistance | : IK07 |
| Led Life Time - L70 | : > 60.500 hours @Ta= 50 °C |

SPRONA

453 W Harbour and Outdoor
LED Area Lighting Luminaire



Photometric Curve

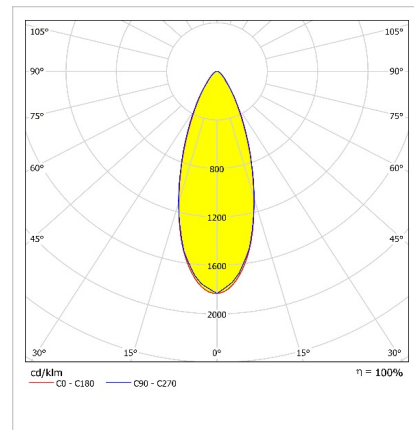

Optional Features

| | |
|-------------------------------|------------------------|
| Correlated Color Temperatures | : 4000K, 5000K, 6500K |
| Angle Options | : 56°, Asymmetric lens |

SPRONA

453 W Harbour and Outdoor LED Area Lighting Luminaire

3120736 SPR 453U 57TF00 36 47K7

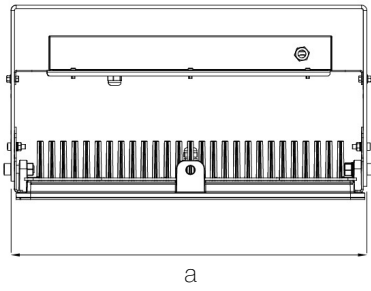

a

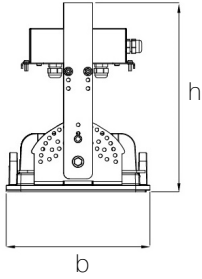

b

Dimensions (mm)

| | a | b | h |
|--------------|-----|-----|-----|
| Single Model | 616 | 249 | 345 |
| Double Model | 616 | 615 | 345 |
| Triple Model | 616 | 980 | 345 |

Weight (kg)

| | |
|--------------|----|
| Single Model | 16 |
| Double Model | 41 |
| Triple Model | 65 |

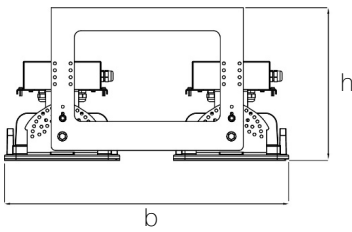

b

Double Model

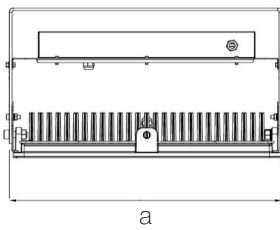

a

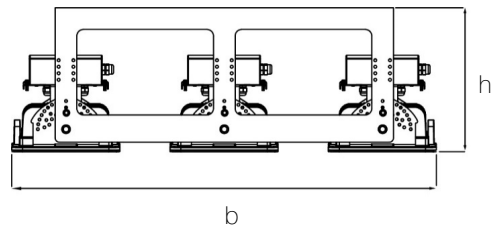

b

Triple Model

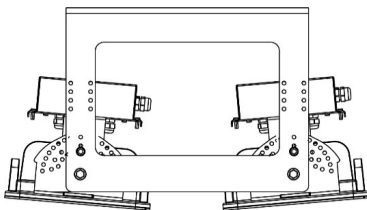

Double Model Movable

90° National position
(In steps of five degrees)

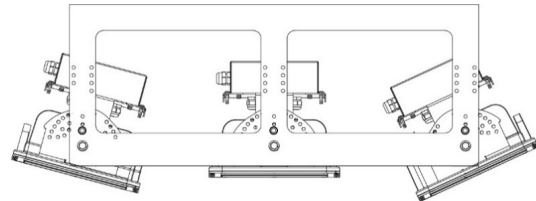

Triple Model Movable

90° National position
(In steps of five degrees)

SPRONA

453 W Harbour and Outdoor LED Area Lighting Luminaire

3120736 SPR 453U 57TF00 36 47K7

Suspension Set

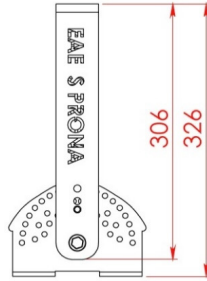
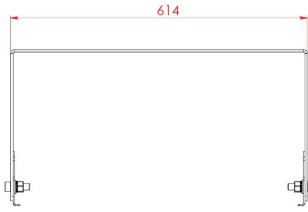

Order Code : 3126252
Product Code : SPR TEKLI ASKI TK

Single Standard Hanger Set

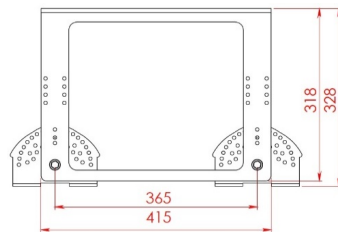
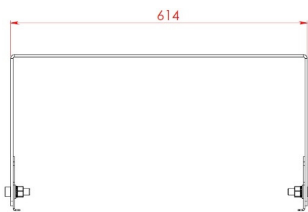

Order Code : 3126251
Product Code : SPR IKILI STD ASKI TK

Double Standard Hanger Set

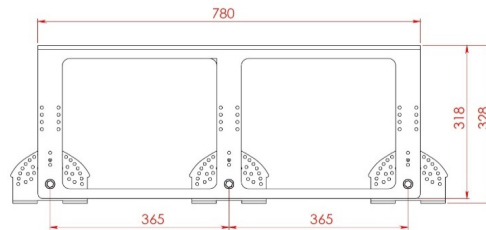
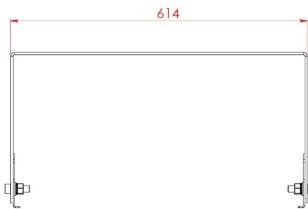

Order Code : 3126255
Product Code : SPR UCLU STD ASKI TK

Triple Standard Hanger Set

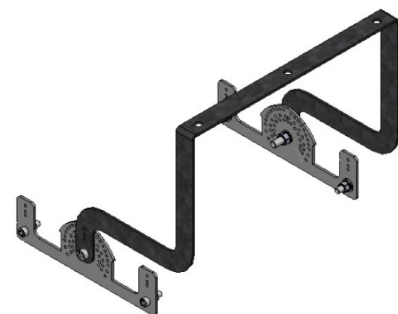
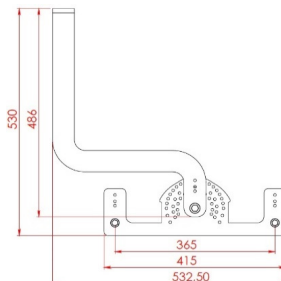
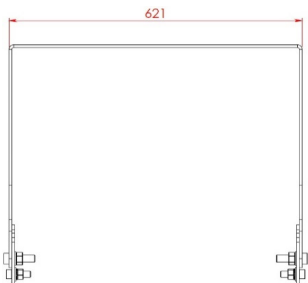

Order Code : 3126250
Product Code : SPR IKILI SEPET ASKI TK

Double Swivel Bracket

SPRONA

453 W Harbour and Outdoor LED Area Lighting Luminaire

3120736 SPR 453U 57TF00 36 47K7

Suspension Set

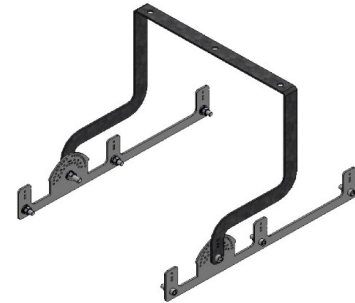
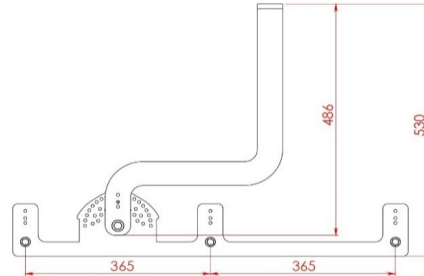
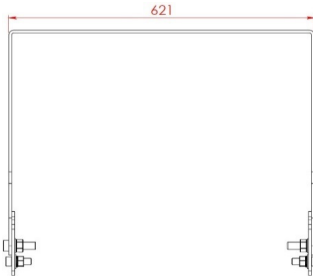

Order Code : 3126254
Product Code : SPR UCLU SEPET ASKI TK

Triple Swivel Bracket

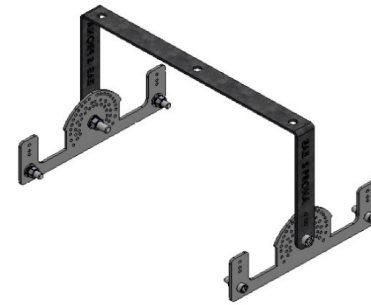
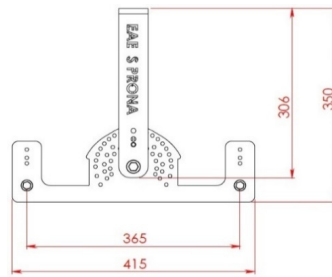
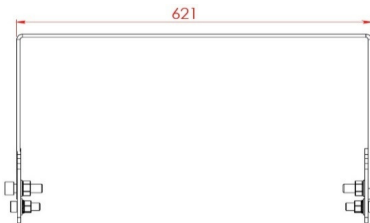

Order Code : 3126249
Product Code : SPR IKILI PROJEKTR ASKI TK

Double Projector Hanger Set

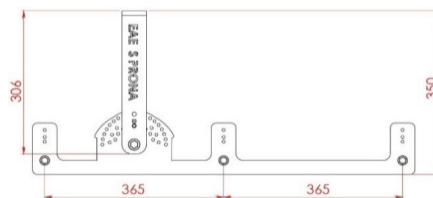
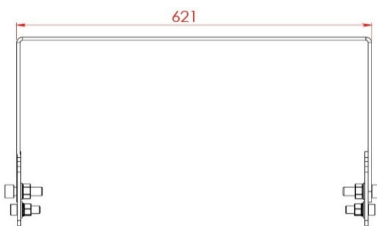

Order Code : 3126253
Product Code : SPR UCLU PROJEKTR ASKI TK

Triple Projector Hanger Set

Energy Conservation Solutions Pty Ltd
Exclusive Distributor for EAE Lighting in Australia
Locations: VIC/TAS, NSW, QLD, ACT, SA/NT & WA
Phone: 1300 306 136
For contact details visit: www.ecs.net.au