



Order Code : 3120748
Product Code : SPR 410U 40TF00 AS 39K0

Product Data

Standard Features

| | |
|--------------|---|
| Housing | : SW 306G painted aluminium injection housing |
| Diffuser | : Tempered transparent glass |
| Optic | : Asymmetric lens |
| IP Grade | : IP66 |
| Installation | : Pole Mounted |
| Light Source | : Power LED |

Optical & Electrical Features

| | |
|------------------------------|----------------|
| Power Consumption | : 408.8 W |
| Final Luminous Flux | : 39054.4 lm |
| Efficacy | : 95.5 lm/W |
| Input Voltage | : 220-240 V AC |
| Frequency | : 50-60 Hz |
| Power Factor | : > 0,9 |
| Surge Transient Protection | : 4 kV |
| Drive Current | : 1050 mA |
| Correlated Color Temperature | : 4000K |
| Color Rendering Index | : >70 |

Other Features & Conditions

| | |
|-----------------------------|-----------------------------|
| Operating Temperature Range | : -40 °C/+50 °C |
| Impact Resistance | : IK07 |
| Led Life Time - L70 | : > 60.500 hours @Ta= 50 °C |

SPRONA

409 W Harbour and Outdoor
LED Area Lighting Luminaire



Photometric Curve

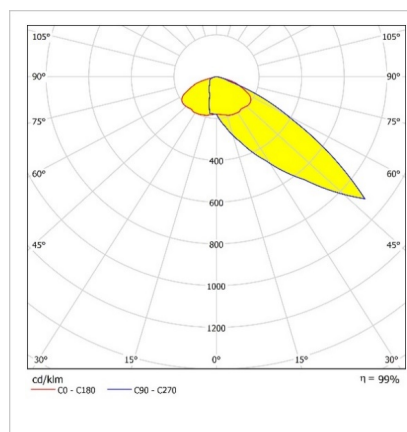

Optional Features

| | |
|-------------------------------|-----------------------|
| Correlated Color Temperatures | : 5000K, 5700K, 6500K |
| Angle Options | : 16° |

SPRONA

409 W Harbour and Outdoor LED Area Lighting Luminaire

3120748 SPR 410U 40TF00 AS 39K0

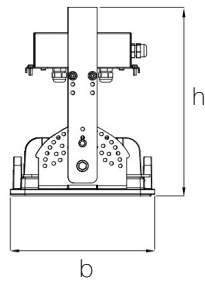
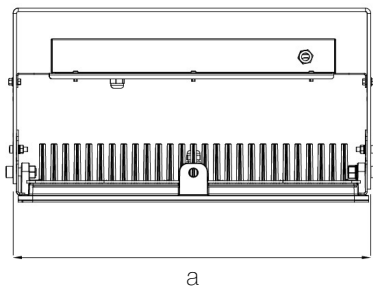

Dimensions (mm)

| | a | b | h |
|--------------|-----|-----|-----|
| Single Model | 616 | 249 | 345 |
| Double Model | 616 | 615 | 345 |
| Triple Model | 616 | 980 | 345 |

Weight (kg)

| | |
|--------------|----|
| Single Model | 16 |
| Double Model | 41 |
| Triple Model | 65 |

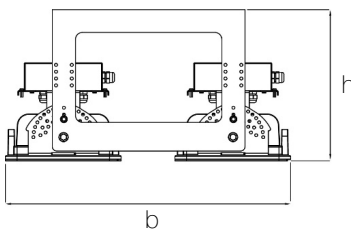

Double Model

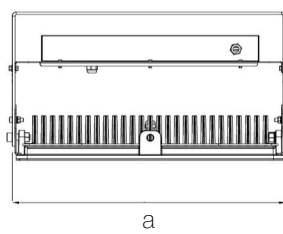

a

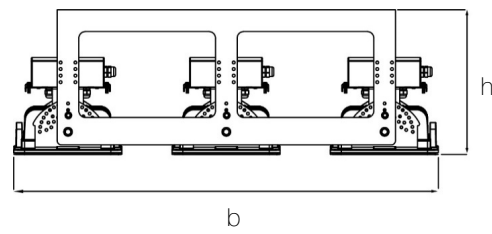

Triple Model

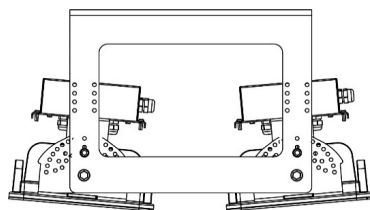

Double Model Movable

90° National position
(In steps of five degrees)

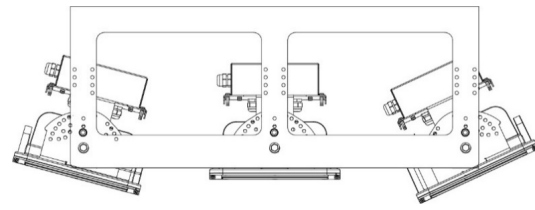

Triple Model Movable

90° National position
(In steps of five degrees)

SPRONA

409 W Harbour and Outdoor LED Area Lighting Luminaire

3120748 SPR 410U 40TF00 AS 39K0

Suspension Set

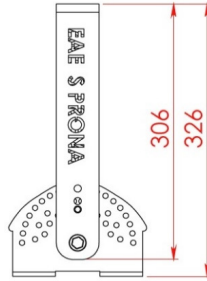
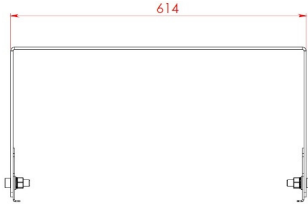

Order Code : 3126252
Product Code : SPR TEKLI ASKI TK

Single Standard Hanger Set

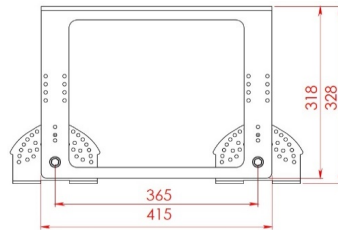
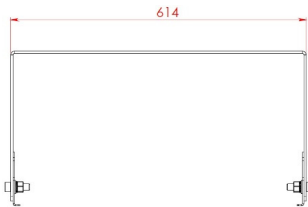

Order Code : 3126251
Product Code : SPR IKILI STD ASKI TK

Double Standard Hanger Set

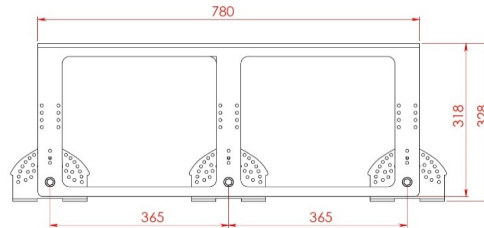
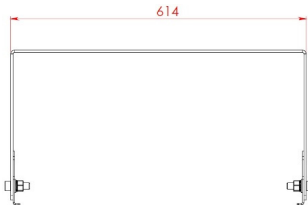

Order Code : 3126255
Product Code : SPR UCLU STD ASKI TK

Triple Standard Hanger Set

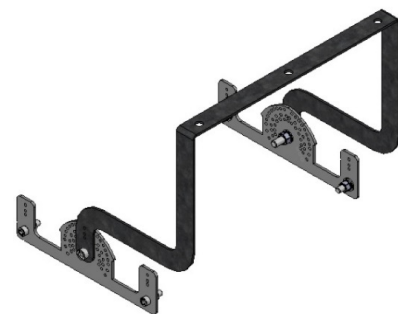
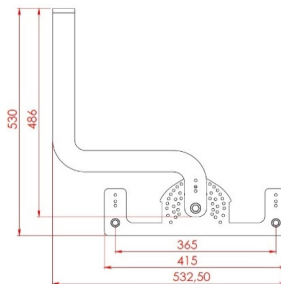
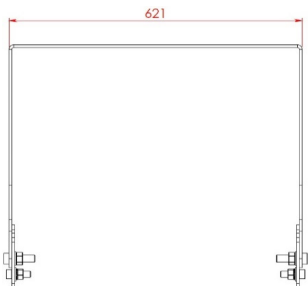

Order Code : 3126250
Product Code : SPR IKILI SEPET ASKI TK

Double Swivel Bracket

SPRONA

409 W Harbour and Outdoor LED Area Lighting Luminaire

3120748 SPR 410U 40TF00 AS 39K0

Suspension Set

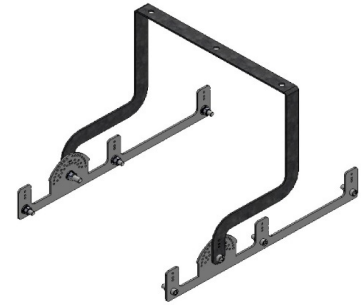
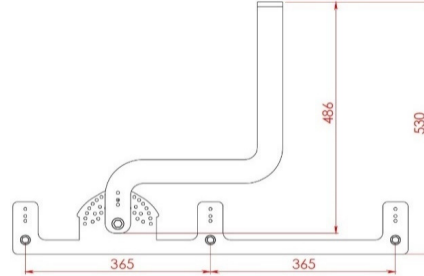
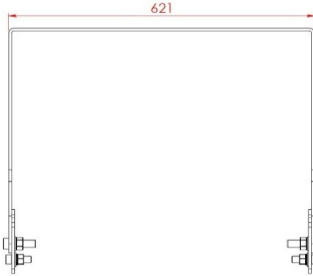

Order Code : 3126254
Product Code : SPR UCLU SEPET ASKI TK

Triple Swivel Bracket

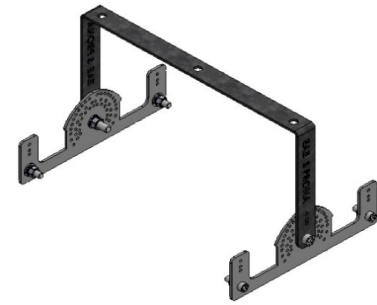
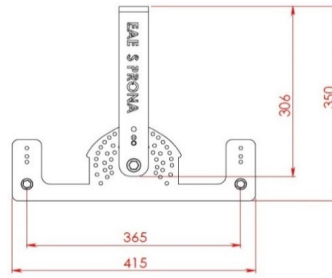
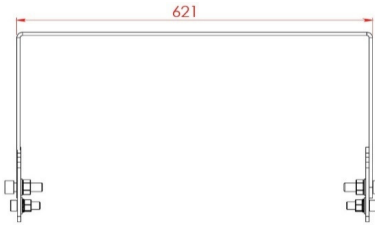

Order Code : 3126249
Product Code : SPR IKILI PROJEKTR ASKI TK

Double Projector Hanger Set

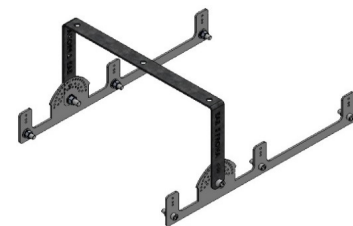
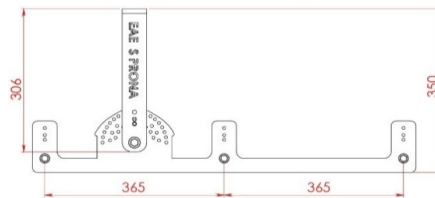

Order Code : 3126253
Product Code : SPR UCLU PROJEKTR ASKI TK

Triple Projector Hanger Set

- EAE, reserves the right to make changes without prior notice.



engineering the light

EAE Aydınlatma A.Ş.
İkitelli Organize Sanayi Bölgesi Eski Turgut Özal Caddesi No:20 Başakşehir / İSTANBUL-TURKEY Phone: +90 212 413 21 00 (pbx) Fax: +90 212 549 37 90
www.eaeaydinlatma.com.tr

Revision date: 14.05.2018